

General Description

The MAX86150 evaluation kit (MAX86150EVSYS#) provides a proven platform to evaluate the MAX86150 integrated photoplethysmogram (PPG) and Electrocardiogram (ECG) sensor module. The EV kit consists of two parts, a MAX86150EVKIT (Bluetooth Low-Energy (BLE) device) and an android tablet with application software pre-installed.

The MAX86150EVKIT BLE device consists of a board that includes the MAX86150 together with 2 stainless steel dry electrodes for ECG evaluation purposes. The EV kit is powered by a single external coin battery (CR2032), as well as +1.8V and +3.3V voltage regulators for the sensor ASIC and the internal LEDs of the MAX86150, respectively.

The EV kit comes with a MAX86150EFN+ in a 22-pin OLGA (Organic Land Grid Array) package.

Features

- Real-Time Monitoring of Optical Reflective PPG and 1 Lead ECG
- Data-Logging Capabilities
- Fully Assembled and Tested
- Integrated and Exchangeable Dry Electrodes

[Ordering Information](#) appears at end of data sheet.

Quick Start

Required Equipment

- MAX86150EVKIT (BLE device)
- 1 x CR2032 lithium coin 3V battery (included)
- Android tablet (included)

Procedure

The EV kit ([Figure 1](#)) is fully assembled and tested. Follow the steps below to verify board operation:

- 1) Turning on the device. Please refer to [Figure 2](#) for details.
 - a. Slide the black slider switch to on. The system will go into low power sleep mode after 1-2 min of inactivity. If on, but asleep, press the “wake-up” push-button (located below and to the left of module).
 - b. Once on, you should see a blue BLE pairing light. If no light is present, check connections or try replacing the CR2032 Li Battery with a fresh one.
- 2) The included tablet comes with the APK software pre-installed.
- 3) Make sure bluetooth is enabled on the tablet provided. **Do not upgrade the preinstalled Android operating system.**
- 4) Open the “**Sensor MAX86150 EV**” Application by clicking the teal Maxim logo ([Figure 3](#)).
- 5) The splash page will first appear as in [Figure 4](#).
- 6) Then, you will need to connect to the BLE EV KIT Hardware. Do this by selecting the “Maxim BT 2.0” that shows up upon opening the android application ([Figure 5](#)).

Note: “Maxim BT #.##” may be vary depending on the firmware version.

Note: The blue LED will stay on until you either swipe left or press the “ECG+PPG” tab at the top.

- 7) After a bluetooth connection is successfully established, the main GUI will launch, as shown in [Figure 6](#).
- 8) Each of the highlighted blocks on the sensor functional block diagram are programmable. Refer to [Detailed Description of GUI](#) for more information.
- 9) Once you have selected the desired settings, swipe **left** or press **“ECG+PPG”** at the top to start PPG+ECG data acquisitions.
- 10) Please refer to [ECG Usage](#) for more details on finger placement.

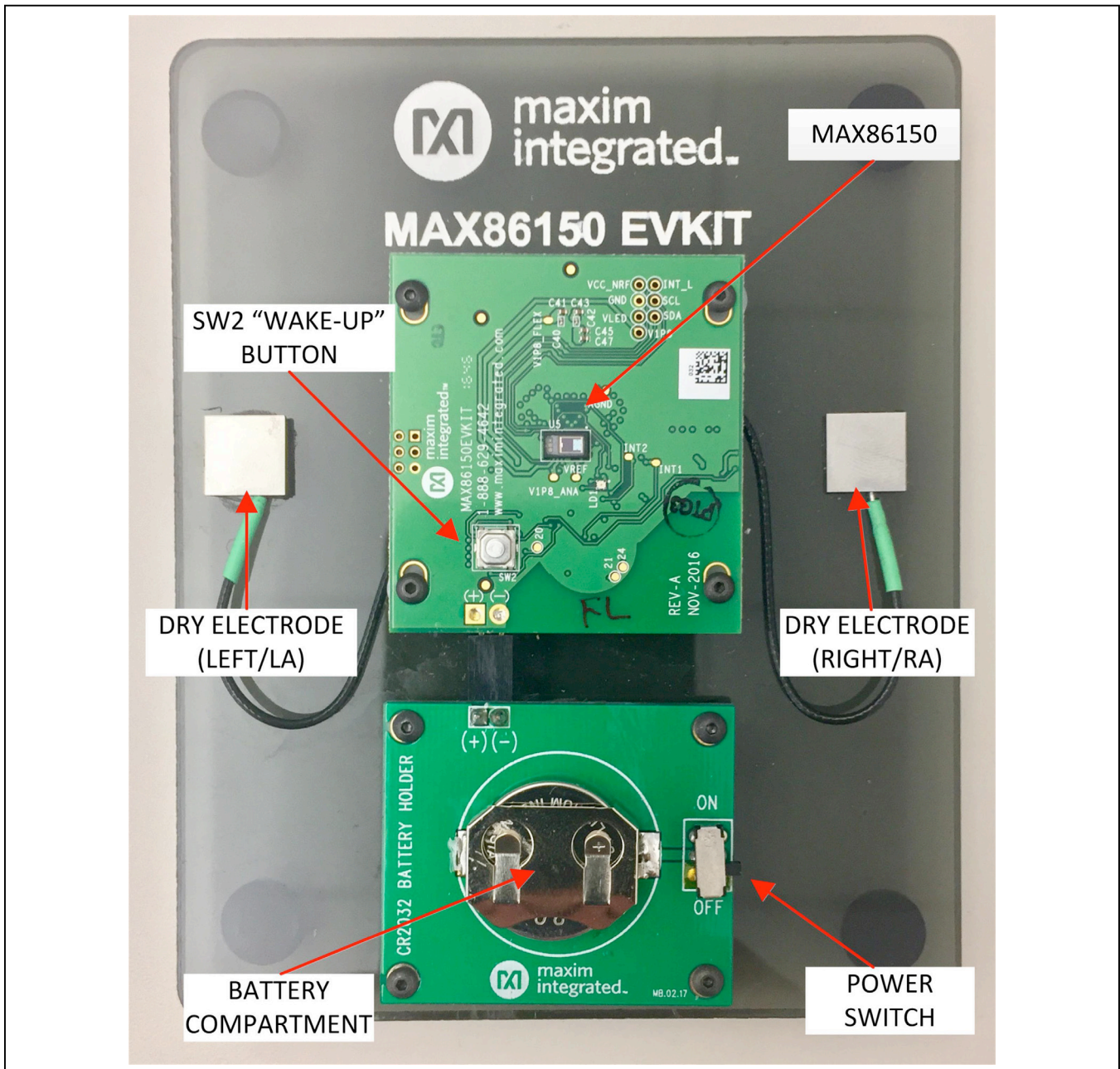

Figure 1. MAX86150 Evaluation Kit

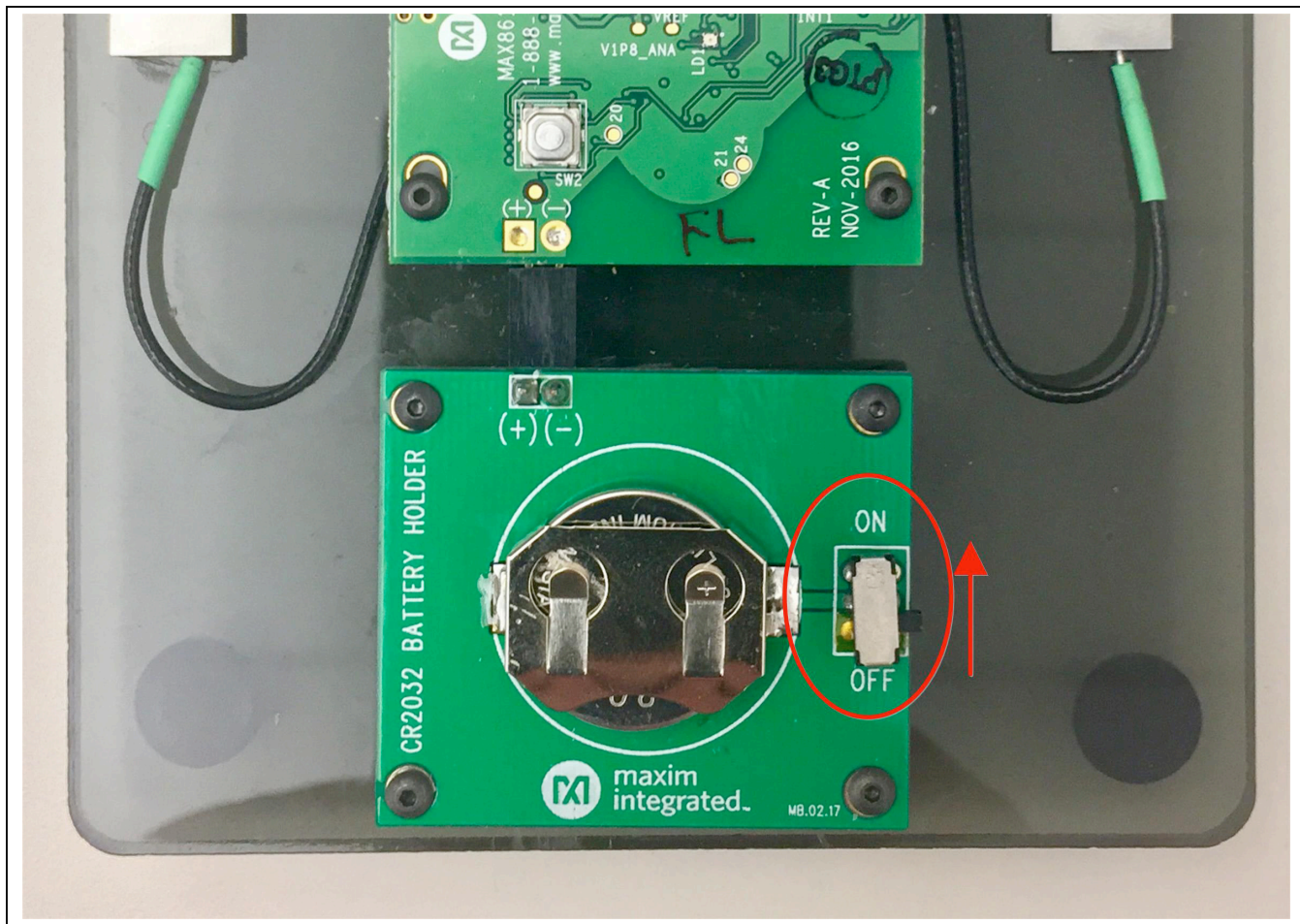

Figure 2. Power Switch



Figure 3. MAX86150 EV Kit Application Launcher

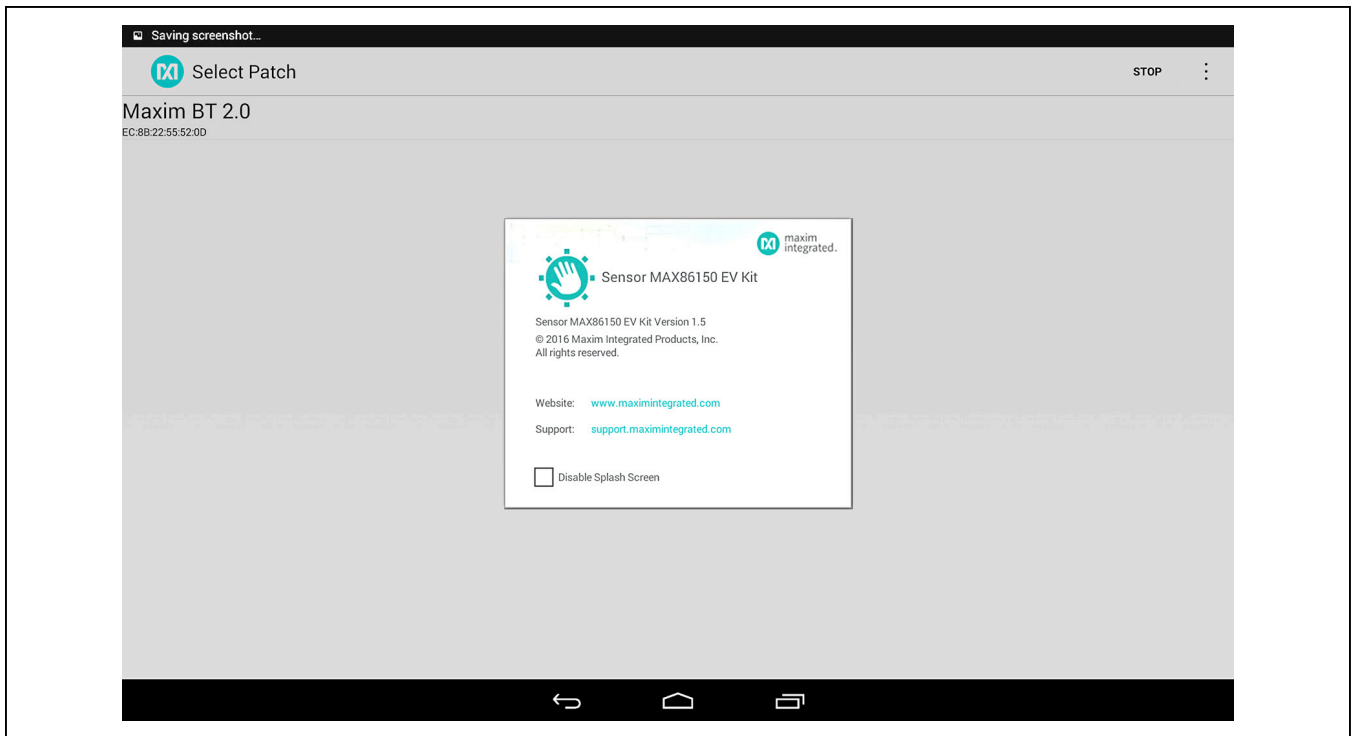

Figure 4. MAX86150 EVKIT Application Splash Screen



Figure 5. Bluetooth Pairing Interface

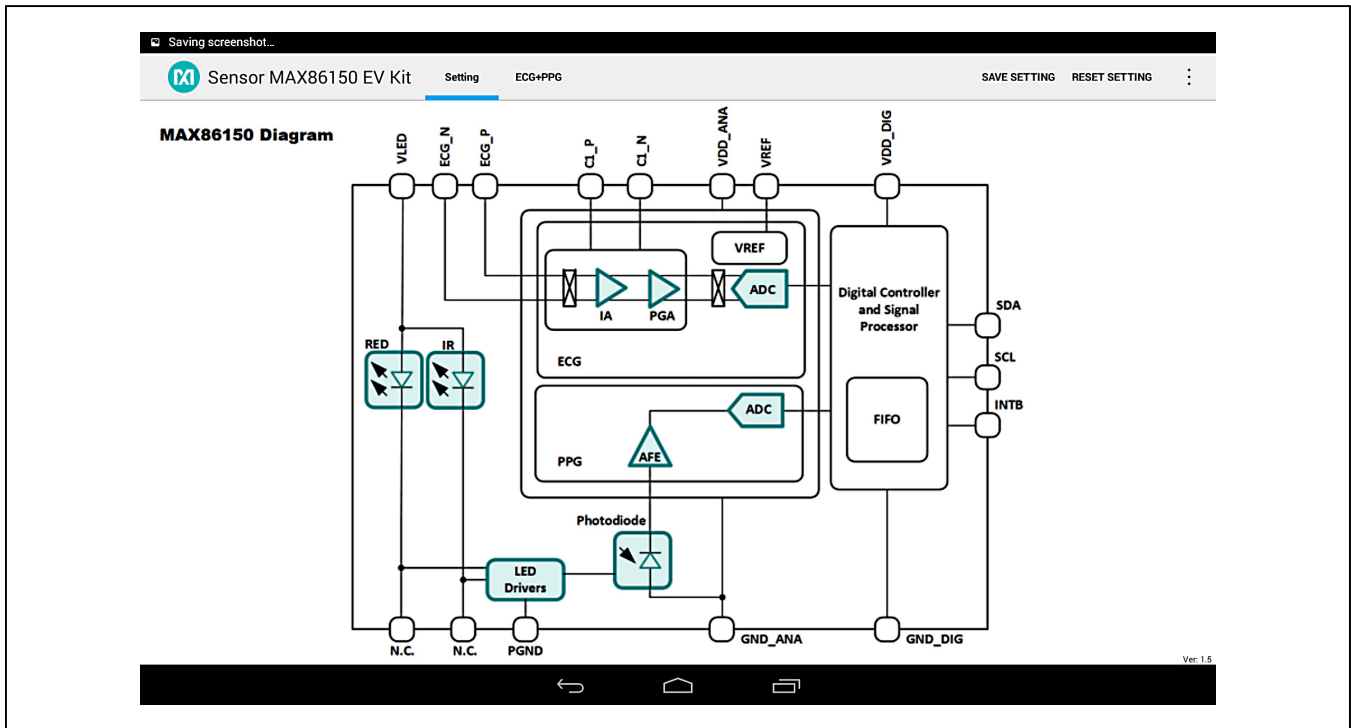

Figure 6. MAX86150 Block Diagram and Configuration Menu

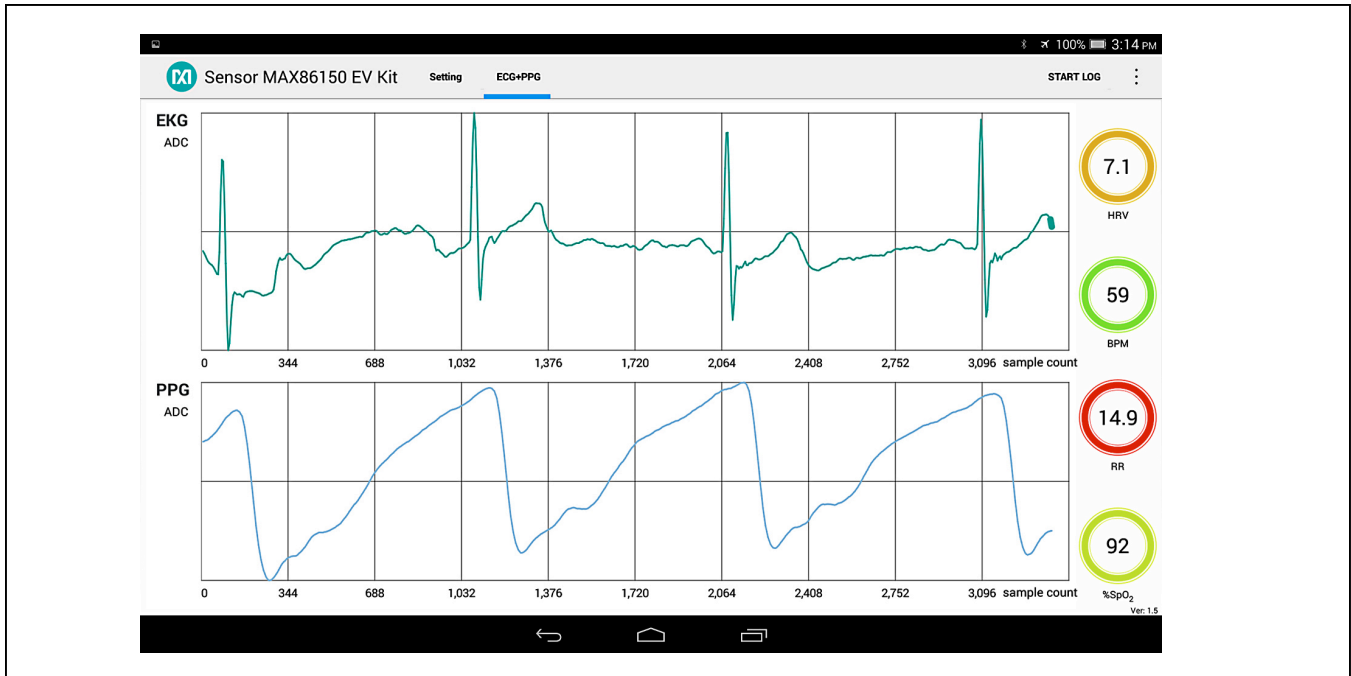

Figure 7. MAX86150 EV Kit ECG and PPG Waveform Display

Detailed Description of GUI

The MAX86150 EV kit applications consist of two main tabs: Setting and ECG+PPG.

Setting Tab

Under the Setting Tab, users have full access to the sensor configurations. With the MAX86150 sensor data sheet handy, select the desired settings by clicking on the **turquoise-colored** components. Please allow a few seconds for the BLE handshake to occur before navigating the configuration menus.

PPG Settings

LED Drivers

By selecting the “LED drivers” button, one can select the maximum LED current range for both Red and IR LED, respectively. After pressing the button, the pop-up menu (shown in [Figure 8](#)) will appear. Select the respective LED range you would like to change and press the button. If IR LED Drivers is chosen, the pop-up menu shown in [Figure 9](#) will appear. Each LED driver consists of four different ranges that can be selected from IR LED Range/Red LED Range.

- 50mA: 0mA–51mA (0.2mA/LSB)
- 100mA: 0mA–102mA (0.4mA/LSB)

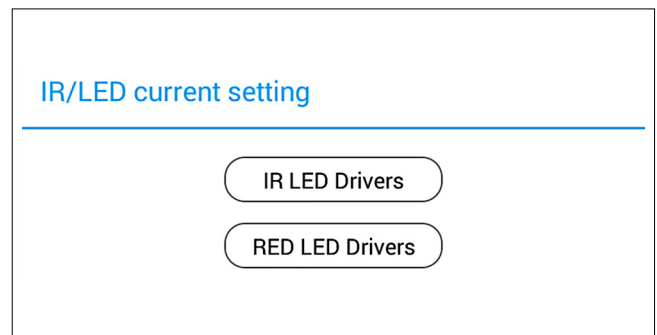

Figure 8. IR/LED current setting

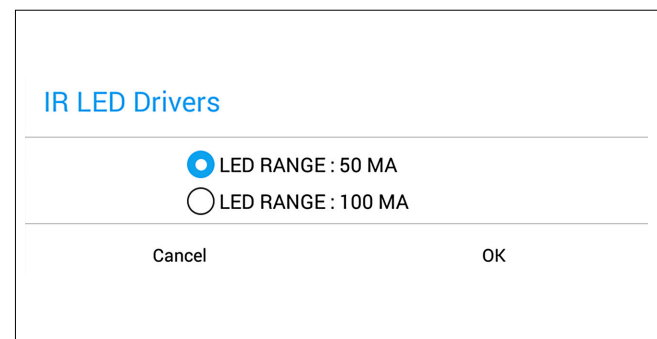

Figure 9. IR LED Drivers (LED Current Range)

RED and IR LED Current

After selecting the maximum LED current range, the drive current of both Red and IR LED can be adjusted individually. If the “Red” button is clicked, the pop-up menu in [Figure 10](#) will appear. To adjust the Red LED current, move the slider left or right to adjust the required LED current levels, and press OK.

PPG Configurations

There are three PPG configurations, accessible by selecting either “AFE” or “ADC” under the PPG Block. The following options will be presented ([Figure 11](#)).

- PPG_ADC_RGE - PPG ADC Full Range
- PPG_SR - PPG Sample Rate
- PPG_SMP_AVG - PPG Sample Average

PPG_ADC_RGE

The **ADC FULL Range** is adjustable from 4096 to 32768nA, as shown in [Figure 12](#).

PPG_SR

The **Sample Rate** drop-down menu is adjustable from 10Hz to 3200Hz, as shown in [Figure 13](#). If the selected sample rate is not supported with the selected pulse width and LED mode, then the highest available sample rate will be automatically set. The user can read back this register to confirm the sample rate. Refer to the MAX86150 data sheet for more details.

Note: The BLE bandwidth cannot support large bandwidth transmissions; samples may be dropped when changing the sample rates and/or sample averaging settings. Supported/default sample rate settings are 200Hz ECG, 100Hz PPG (100Hz Red, 100Hz IR). This is a Bluetooth LE limitation, not a device limitation.

PPG_SMP_AVG

To reduce the amount of data throughput, adjacent samples (in each individual channel) can be averaged and decimated on the chip by setting this register. These bits set the number of samples that are averaged on-chip before being written to the FIFO.

The **Sample Averaging** drop-down menu is adjustable from 1 to 32, as shown in [Figure 14](#).

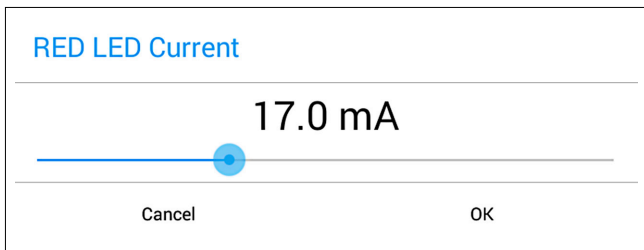

Figure 10. RED LED Current

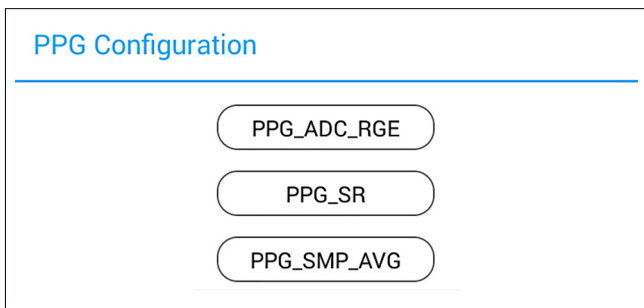

Figure 11. PPG Configuration

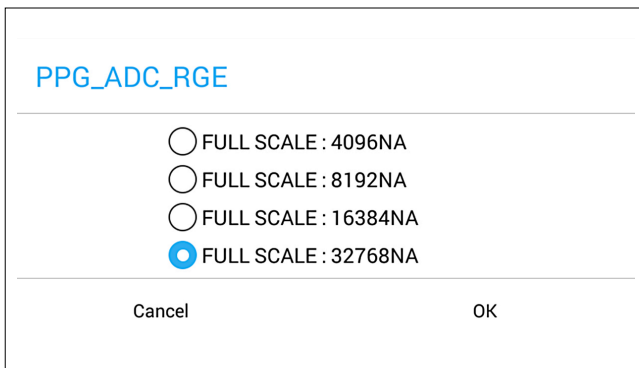

Figure 12. PPG ADC Full Range

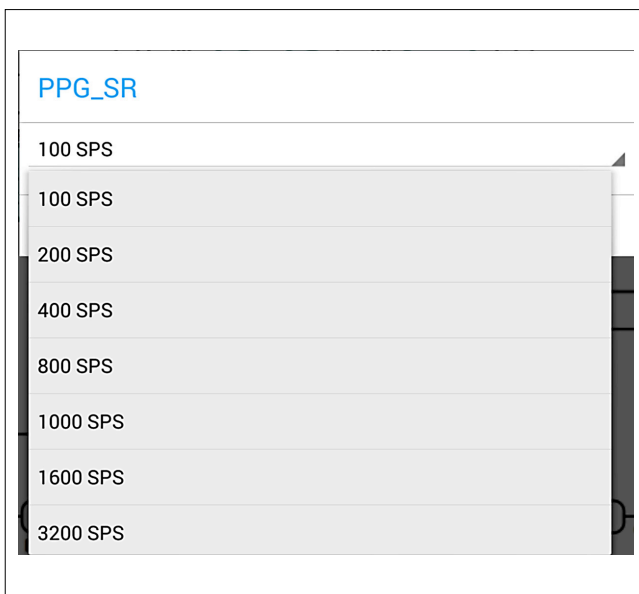

Figure 13. PPG Sample Rate

PPG_LED_PW

The pulse width of the LED drivers, and the integration time of PPG ADC, can be adjusted by pressing “Photodiode” in the block diagram. The **Pulse Width** list is adjustable from 50µs to 400µs, as shown in Figure 15. The maximum supported sample rates are also determined by the pulse widths and number of LEDs used. Refer to the MAX86150 data sheet for details.

ECG Configurations

ECG Sample Rate

By selecting “ADC” under the ECG block, the ECG sample rate can be set as shown in Figure 16. These bits set the oversampling ratio (OSR) of the ECG ADC. **ECG_ADC_OSR<1:0>** together with the ADC clock frequency and (**ECG_ADC_CLK[2]**) set the ECG sample rate. Refer to the MAX86150 data sheet for the filter bandwidth of each option.

Note: The BLE bandwidth cannot support large bandwidth transmissions; samples may be dropped when changing the sample rates and/or sample averaging settings. Supported/default sample rate settings are 200Hz ECG, 100Hz PPG (100Hz Red, 100Hz IR). This is a Bluetooth LE limitation, not a device limitation.

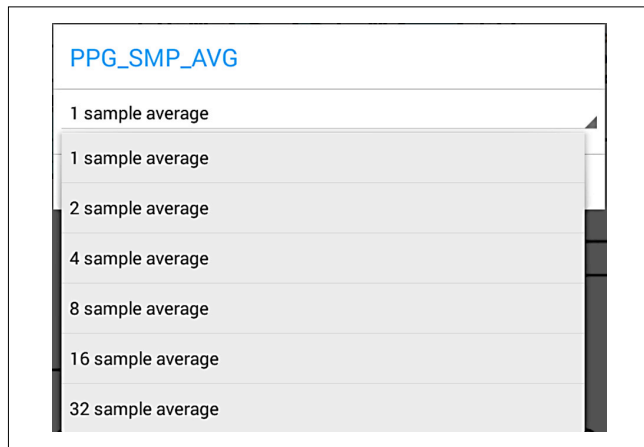

Figure 14. PPG Sample Averaging

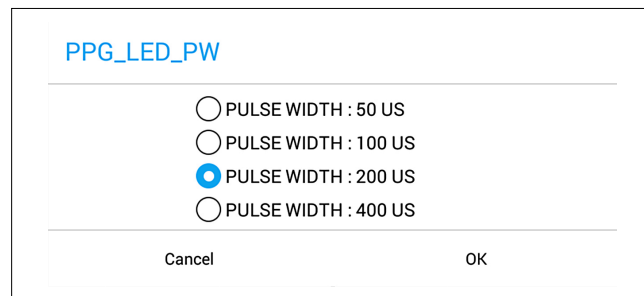

Figure 15. PPG LED Pulse Width

ECG PGA Gain

ECG PGA Gain options can be set by selecting “PGA” under the ECG block, as shown in Figure 17. The **ECG PGA Gain** drop-down list is adjustable from 1 to 8V/V.

ECG IA Gain

ECG Instrumentation Amplifier Gain options can be set by selecting “IA” under the ECG block, as shown in Figure 18. The **ECG IA Gain** drop-down list is adjustable from 5 to 50V/V.

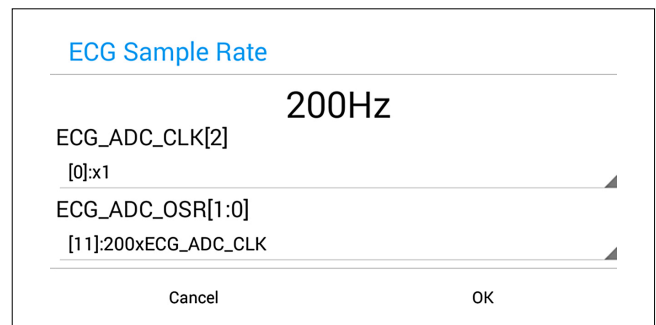

Figure 16. ECG Sample Rate

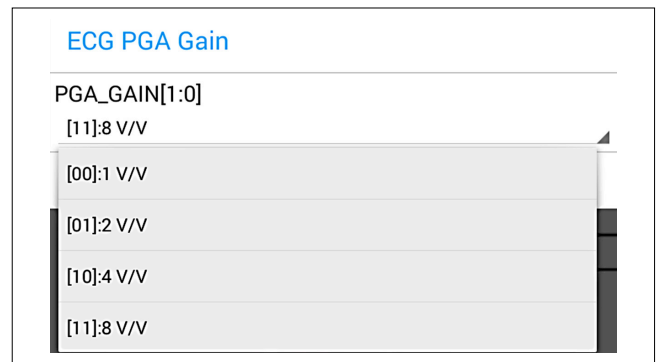

Figure 17. ECG PGA Gain



Figure 18. ECG IA Gain

Menu Buttons

RESET Setting and SAVE Setting

In order to reset the register settings to the EV kit's default settings, press "RESET SETTING" in the upper-right-hand corner.

The default register settings are

- ECG_SR – 200Hz
- PPG_SR – 100Hz
- LED currents (Red and IR) – 17mA
- ADC Full-Scale Current – 32768 μ A
- LED Pulse Width – 200 μ S
- ECG Gain – $9.5 \times 8 = 76V/V$
- ECG_ADC_CLK = 1

Additionally, you can save your current configuration to a file for later retrieval. The files are located in the tablet's main directory, entitled "ekgppg_setting_DATE_TIME.txt".

Data Logging

To save logging data, click "START LOG" in the upper-right-hand corner of the ECG+PPG screen that displays the waveforms. This will log and timestamp Red LED, IR LED, Filtered ECG, Raw ECG, HR (BPM), SpO₂, HRV (Heart Rate Variability), RR (Respiration Rate), and other information into a csv file located in the tablet's main directory, entitled "ecgppg_DATE_TIME.csv".

Detailed Description of Hardware and Usage

Turning on the Device

Slide the black switch on the battery compartment to ON. The system will go into low-power sleep mode after 1-2 minutes of inactivity. If on, but asleep, press "wake-up" push-button (SW2 – located below and to the left of module).

Once it's turned on, you should see a blue light (LD1). If no light is present, check connections or try replacing the CR2032 Li battery with a fresh one.

Make sure bluetooth is enabled on the provided tablet. Do **not** upgrade the operating system. Open the "Sensor MAX86150 EV" by clicking the teal logo. Then, follow the Quick Start → Procedure for details on EV kit operation.

If you are either unable to connect, or do not see the "Maxim BT 2.0" upon android application launch, make sure bluetooth is enabled, the device is powered on, and the blue LED is illuminated. The provided tablet's bluetooth functionality

occasionally needs to be toggled off and on to flush the BLE stack. Try turning the bluetooth off and then on from the swipe-down menu on the top-left side of the tablet.

Lights/Battery

The EV kit has a blue LED indicator light (LD1). The blue light means that the BLE chipset is in advertising mode. The device will stay in this mode until you either swipe left, or press the "ECG+PPG" button in the Android application. At this point, the settings are sent to the device and the handshake is completed, allowing data transmission to begin.

If the blue light is faint, replace the coin cell battery, making sure to place the + side down, as shown in [Figure 19](#). The battery compartment can be removed from the EV kit for easy battery replacement. **Only one coin cell battery is required.**

ECG Usage

The EV kit has two electrodes. These dry stainless steel electrodes have left and right-hand polarities, and should be contacted such that your middle or index finger is over the sensor, as shown in [Figure 20](#). Both hands must touch the electrodes to measure the electrocardiogram waveform potential. Additionally, PPG signal can be measured simultaneously by using another finger from either hand. Make sure the left and right hand do not touch (electrically short) during the measurement.

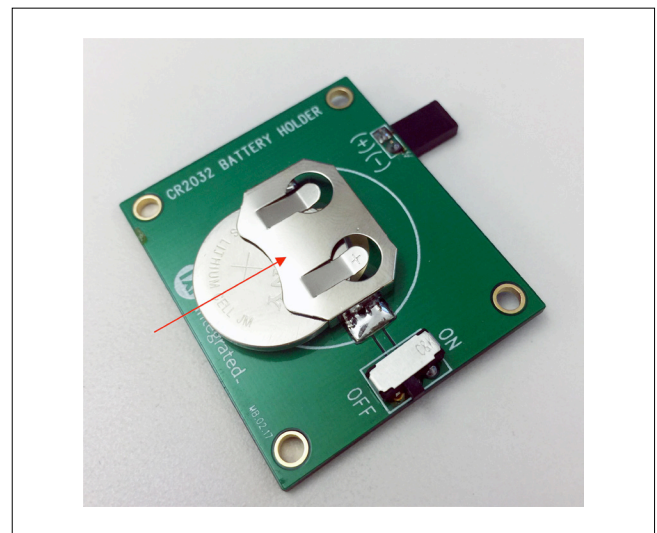

Figure 19. Battery Compartment.

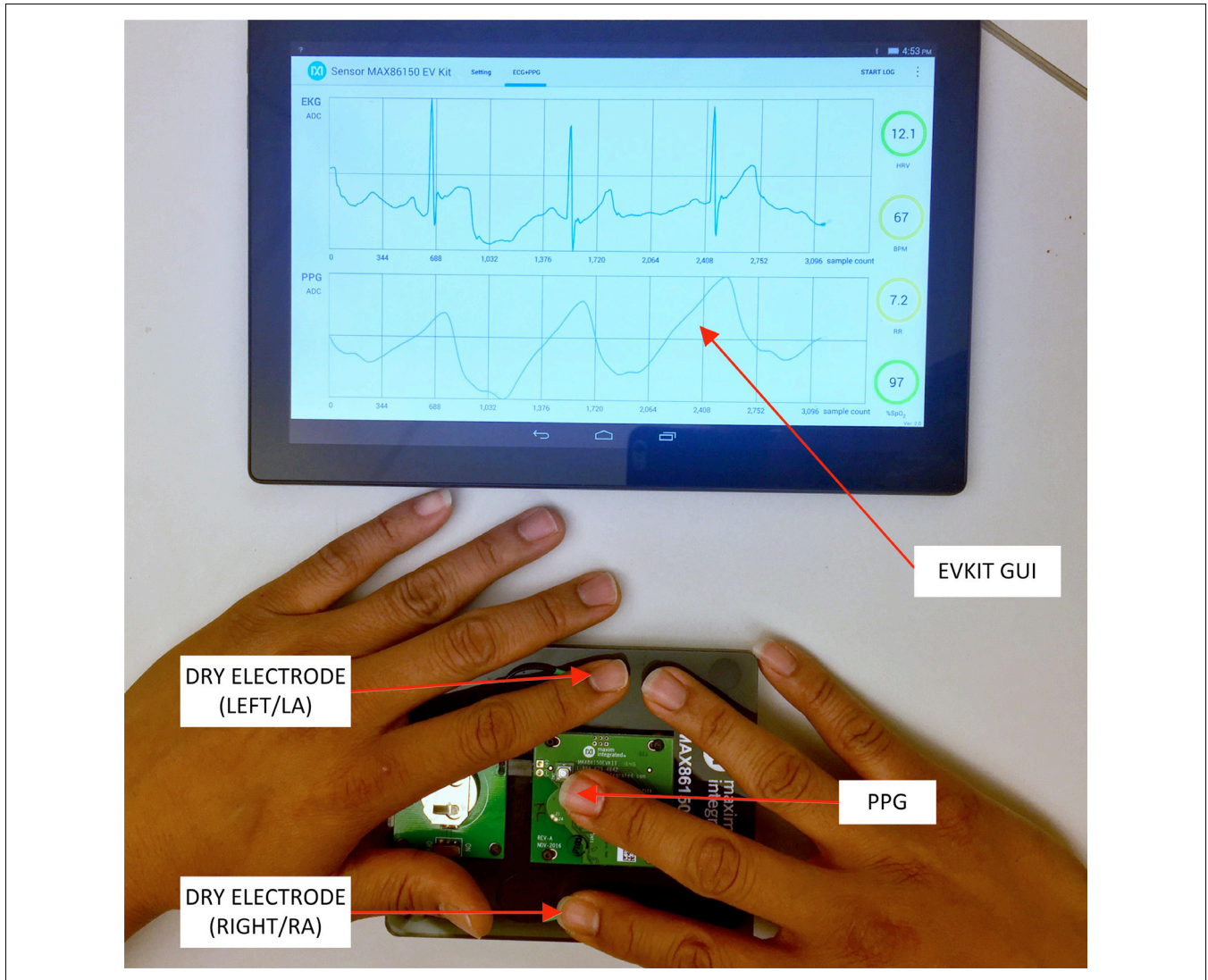

Figure 20. Fingers Over Sensor Module

Ordering Information

PART	TYPE
MAX86150EVSYS#	EV Kit

#Denotes RoHS compliant.

MAX86150 EV Kit Bill of Materials

PART	QTY	DESCRIPTION
Lenovo Tab2-A1070F	1	Tablet PC
MAX86150EVKIT	1	MAX86150 BLE EVKIT

S.NO	REF DES	QTY	VALUE	JEDEC_TYPE	MFR_PN	MFR	DESCRIPTION
1	B1	1	BAL-NRF02D3	BAL-ST-WLCSP	BAL-NRF02D3	STMicroelectronics	IC BALUN FOR NRF51822 WLCSP
2	C1,C2,C13,C14	4	12pF	CAPC1005X04L	GRM1555C1E120GA01D	Murata	CAP CER 12PF 25V 2% NP0 0402
3	C3	1	2.2nF	CAPC1005X04L	GRM155R71C222KA01D	Murata	CAP CER 2200PF 16V 10% X7R 0402
4	C4	1	1.2pF	CAPC1005X04L	GRM1555C1E1R2BA01D	Murata	CAP CER 1.2PF 25V NP0 0402
5	C5,C30	2	220uF	CASE-B	TCJB227M004R0035	AVX	CAP TANT POLY 220UF 4V 1210
6	C6,C15,C27	3	10uF	CAPC0402	CL05A106MP5NUNC	Samsung	CAP CER 10UF 10V 20% X5R 0402
7	C7,C11,C16,C17,C18,C28,C34,C36,C38,C40,C42,C48	12	0.1uF	CAPC0201	C0603X5R1C104K030BC	TDK Corporation	CAP CER 0.1UF 16V 10% X5R 0201
8	C8	1	100nF	CAPC1005X04L	GRM155R71C104KA88D	Murata	CAP CER 0.1UF 16V 10% X7R 0402
9	C9	1	1.0nF	CAPC1005X04L	GRM155R71C102KA01D	Murata	CAP CER 1000PF 16V 10% X7R 0402
10	C10	1	47nF	CAPC1005X04L	GRM155R71C473KA01D	Murata	CAP CER 0.047UF 16V 10% X7R 0402
11	C12	1	0.1uF	CAPC0402	C1005X5R1E104K050BC	TDK Corporation	CAP CER 0.1UF 25V 10% X5R 0402
12	C19,C20	2	1.0uF	CAPC0201	C0603X5R0J105M030BC	TDK Corporation	CAP CER 1UF 6.3V 20% X5R 0201
13	C21	1	33uF	CASE-A	T520A336M006ATE070	Kemet	CAP TANT 33UF 6.3V 20% 1206
14	C29	1	22nF	CAPC0201	C0603X5R1E223K030BB	TDK Corporation	CAP CER 0.022UF 25V 10% X5R 0201
15	C31	1	1.0uF	CAPC0402	CL05A105JQ5NNNC	Samsung	CAP CER 1UF 6.3V 5% X5R 0402
16	C32,C33	2	10pF_COG	CAPC0402	GRM1555C1H100FA01D	Murata	CAP CER 10PF 50V NP0 0402
17	C35,C37,C39,C41,C43,C45,C47,C49	8	2.2uF	CAPC0402	C1005X5R1A225K050BC	TDK Corporation	CAP CER 2.2UF 10V X5R 0402
18	FB1,FB2	2	80 ohm	FB0402	BLM15PD800SN1D	Murata	FERRITE CHIP 80Ω 1500MA 0402
19	J7	1	HDR_TH_2X1	HDR_TH_2X1_100MIL	-	-	-
20	J8,J9	2	128-0711-201	UMC_128_0711_201	128-0711-201	Cinch Connectivity Solutions Johnson	CONN UMC RCPT STR 50Ω SMD
21	J10	1	BM20B(0.8)-10DP-0.4V(53)	BM20B_0_8_10DP_0_4V_53	BM20B(0.8)-10DP-0.4V(53)	Hirose Electric Co Ltd	CONN HDR 10POS 0.4MM SMD
22	LD1	1	TRICOLOR_LED	SML-LX0404SIUPGUSB	SML-LX0404SIUPGUSB	Lumex	LED RGB CLEAR 0404 SMD
23	L1	1	2.2nH	INDC1005X04L	LQP15MN2N2B02D	Murata	FIXED IND 2.2NH 220MA 300 MΩ
24	L2	1	4.7uH	IND_74404024047	74404024047	Würth Electronics Inc	FIXED IND 4.7UH 1.1A 175 MΩ
25	P2	1	HDR_2MM	2X3_2MM	Do Not load		CBL PLUG-OF-NAILS 6-PIN
26	R1	1	1.69M	RES0402	CRCW04021M69FKED	Vishay	RES SMD 1.69MΩ 1% 1/16W 0402
27	R2	1	680	RES0201	MCR006YRTF6800	Rohm	RES 680 OHM 1/20W 1% 0201 SMD
28	R3	1	1M	RES0201	CRCW02011M00FNED	Vishay	RES SMD 1MΩ 1% 1/20W 0201
29	R4	1	820	RES0201	MCR006YRTF8200	Rohm	RES SMD 820Ω 1% 1/20W 0201
30	R5	1	2M	RES0201	CRCW02012M00FNED	Vishay	RES SMD 2MΩ 1% 1/20W 0201
31	R6	1	10M	RES0201	CRCW020110M0FNED	Vishay	RES SMD 10MΩ 1% 1/20W 0201
32	R7,R9, R22,R23	4	4.7K	RES0201	MCR006YRTF4701	Rohm	RES 4.7KΩ 1/20W 1% 0201 SMD

MAX86150 EV Kit Bill of Materials (continued)

S.NO	REF DES	QTY	VALUE	JEDEC_TYPE	MFR_PN	MFR	DESCRIPTION
33	R8	1	10K	RES0201	CRCW020110K0FKED	Vishay	RES 10.0KΩ 1/20W 1% 0201 SMD
34	R10	1	10K	RES0603	RNCS0603BKE10K0	Stackpole	RES SMD 10KΩ 0.1% 1/16W 0603
35	R11	1	10K	RES0201	CRCW020110K0FKED	Vishay	RES 10.0KΩ 1/20W 1% 0201 SMD
36	R12	1	1K	RES0201	CRCW02011K00FKED	Vishay	RES SMD 1KΩ 1% 1/20W 0201
37	R13	1	2.2M	RES0201	CRCW02012M20FNED	Vishay	RES SMD 2.2MΩ 1% 1/20W 0201
38	R14,R28	2	0	RES0201	ERJ-1GN0R00C	Rohm	RES SMD 0.0Ω JUMPER 1/20W 0201
39	R15,R16,R17	3	DNL	RES0201	MCR006YRTF4701	Rohm	RES 4.7KΩ 1/20W 1% 0201 SMD
40	R29,R20,R21	3	0	RES0201	ERJ-1GN0R00C	Panasonic	RES SMD 0.0Ω JUMPER 1/20W 0201
41	R19,R18	2	DNL	RES0201	ERJ-1GN0R00C	Panasonic	RES SMD 0.0Ω JUMPER 1/20W 0201
42	R24	1	0	RES0603	ERJ-3GEY0R00V	Panasonic	RES SMD 0.0Ω JUMPER 1/10W 0603
43	R25,R26	2	49.9K_0.1%	RES0402	ERA-2AEB4992X	Panasonic	RES SMD 49.9KΩ 0.1% 1/16W 0402
44	SW1	1	CVS-01TB	SPST_CVS-01TB	CVS-01TB	Copal Electronics Inc.	SWITCH DIP SLIDE 1-POS 1MM 6V
45	SW2	1	SW PUSHBUTTON	SW_TACTILE_4_90x4_90MM	EVQ-PLMA15	Panasonic Electronic Components	SWITCH TACTILE SPST-NO 0.02A 15V
46	TP1	1	TP_SMD	TP_SMD_1	-	-	Test Point, Imprinted on PCB, Do not install
47	TP2	1	TP_SMD	TP_SMD_2	-	-	Test Point, Imprinted on PCB, Do not install
48	TP3	1	TP_SMD	TP_SMD_3	-	-	Test Point, Imprinted on PCB, Do not install
49	TP4	1	TP_SMD	TP_SMD_4	-	-	Test Point, Imprinted on PCB, Do not install
50	TP5	1	TP_SMD	TP_SMD_5	-	-	Test Point, Imprinted on PCB, Do not install
51	TP6	1	TP_SMD	TP_SMD_6	-	-	Test Point, Imprinted on PCB, Do not install
52	TP7,TP8,TP9, TP10, TP11, TP13	6	TP_SMD	TP_SMD	-	-	Test Point, Imprinted on PCB, Do not install
53	TP12	1	TP_SMD	TP_SMD_7	-	-	Test Point, Imprinted on PCB, Do not install
54	U1	1	NRF51822-CFAC	BGA62C40P9X9_383X383X55	NRF51822-CFAC-R	Nordic Semiconductor	IC SOC 2.4GHZ MULTIPROTO 62WLCS
55	U2	1	ACCEL/ GYROSCOPE	LGA16_MAX21100	MAX21105ELE+	MAXIM	IC ACCEL/GYROSCOPE SENSOR 16LGA
56	U3	1	BOOST REGULATOR	TDFN8_MCP16251	MCP16251T-1MNY	Microchip	IC REG BST SYNC ADJ 0.1A 8TDFN
57	U4	1	1.8V LDO	BU18TA2WNVX-TR	BU18TA2WNVX-TR	ROHM	IC REG LDO 1.8V 0.2A 4SSON
58	U5	1	MAX86150 SENSOR	MAX86150_22PIN	MAX86150+T	Maxim	Integrated BIO Module for Mobile Health
59	X1	1	16MHz	BT-XTAL_2520	NX2520SA-16MHZ-STD-CSW-5	NDK	XTAL SMD 2520, 16MHz, 8pF, 715ppm
60	X2	1	32.768kHz	FC-135	FC-135 32.7680KA-AC	Epson Toyocom	CRYSTAL 32.768KHZ 9PF SMD
61	20,21,24	3	Dia_1mm_SMD	TP_SMD_I1_0MM	-	-	1.0mm circular SMD testpad
62	MAX86150 EVKIT BRD PCB	1			305-PD-15-0861	PACTRON	

MAX86150 EV Kit Schematic

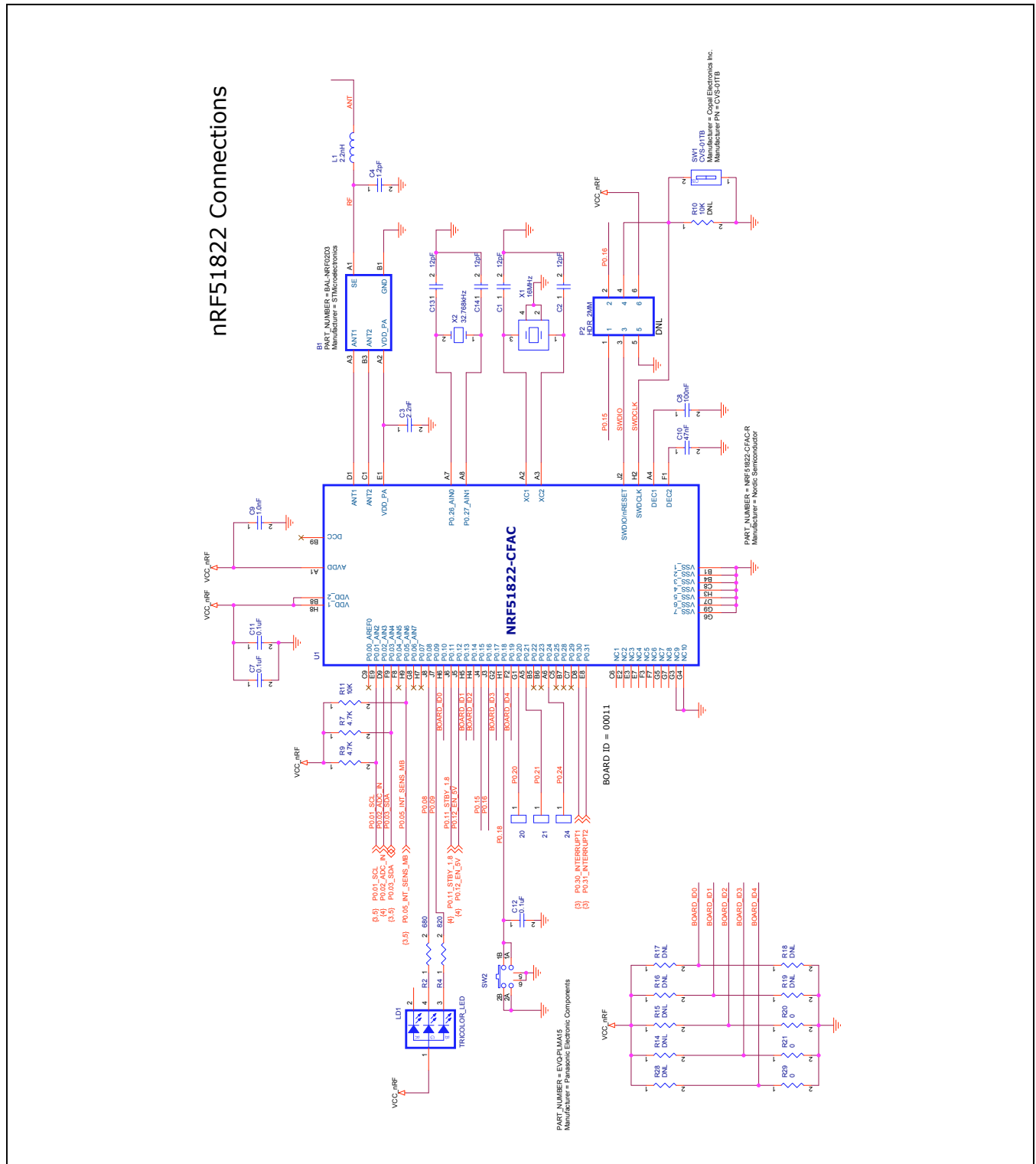

MAX86150 EV Kit Schematic (continued)

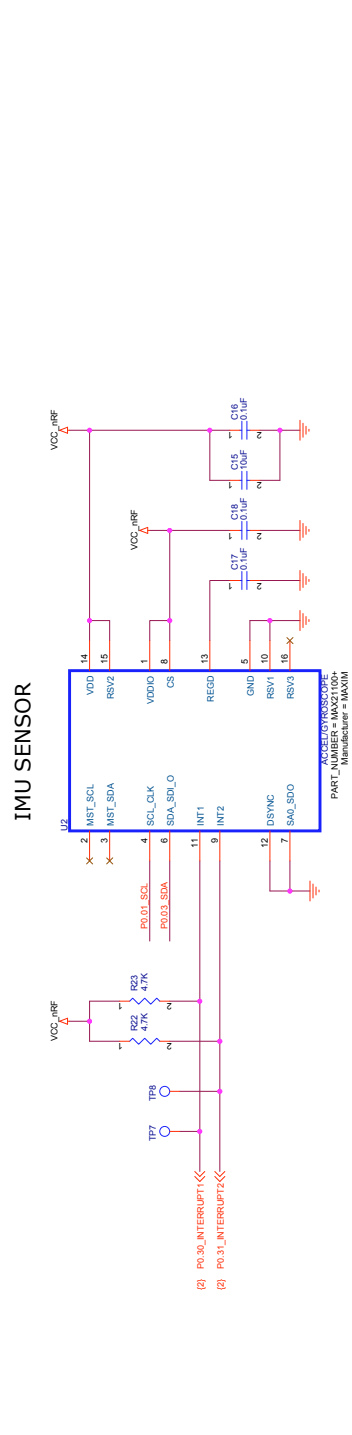
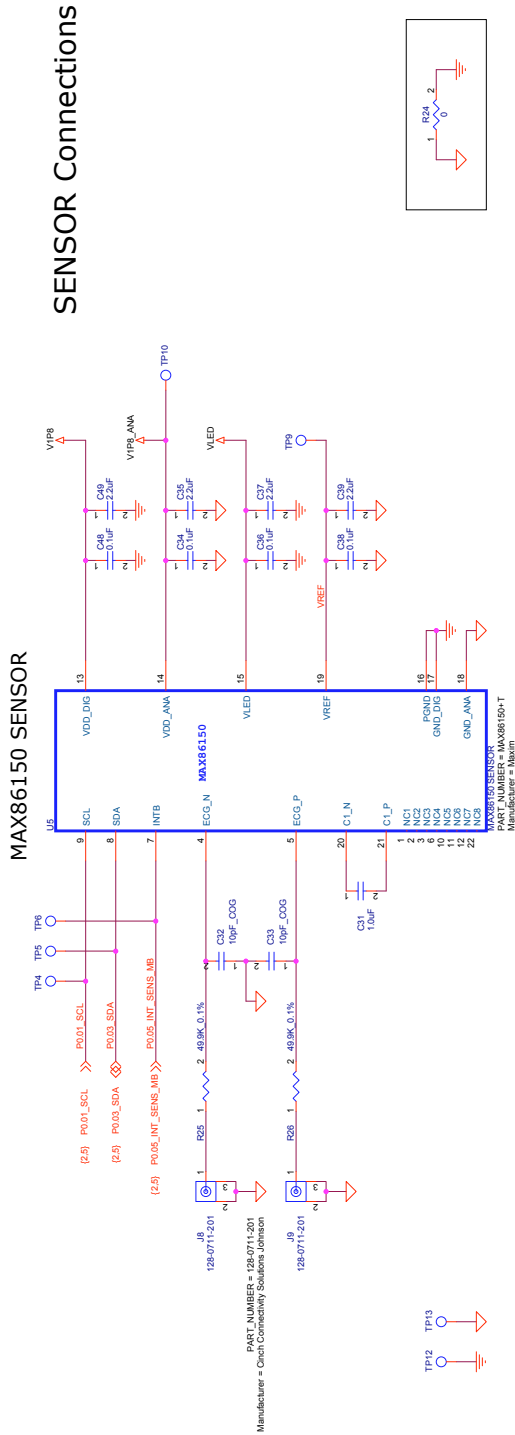

MAX86150 EV Kit Schematic (continued)

REGULATOR CONNECTIONS

BOOST REGULATOR

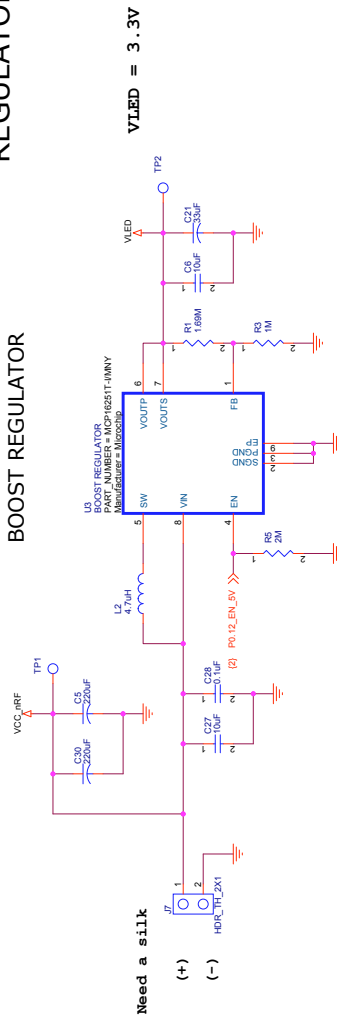

1.8V LDO

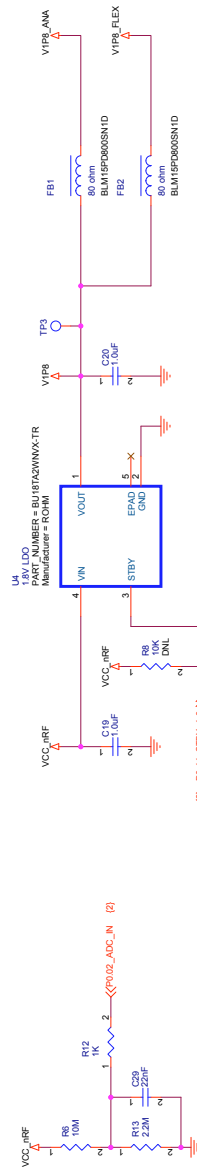

MAX86150 EV Kit Schematic (continued)

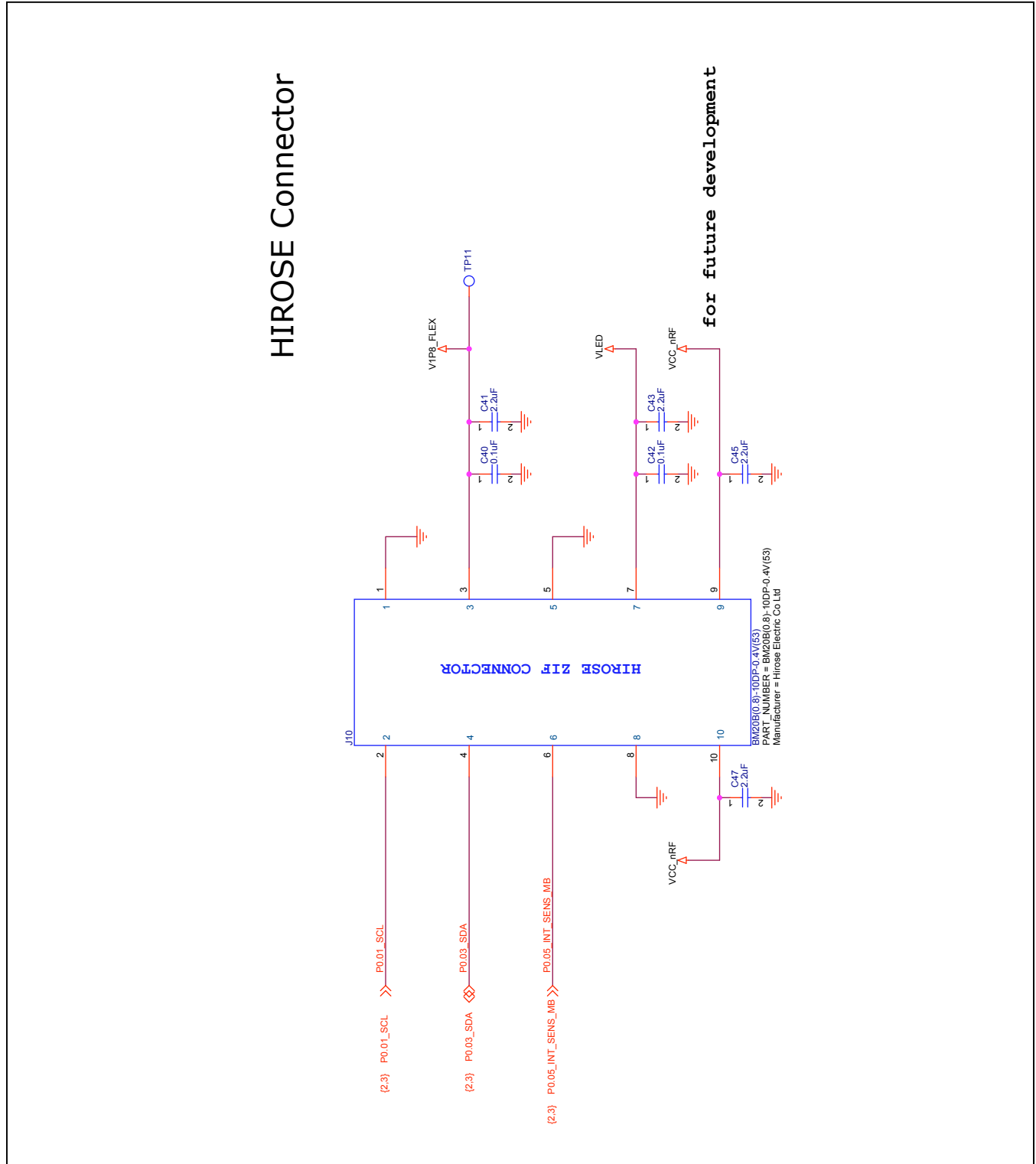

MAX86150 EV Kit PCB Layouts

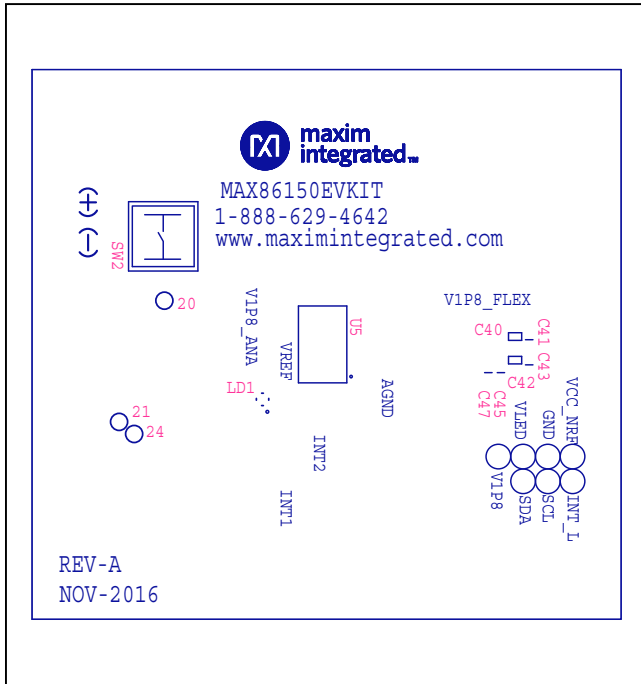

MAX86150 EV Kit—Top Silkscreen

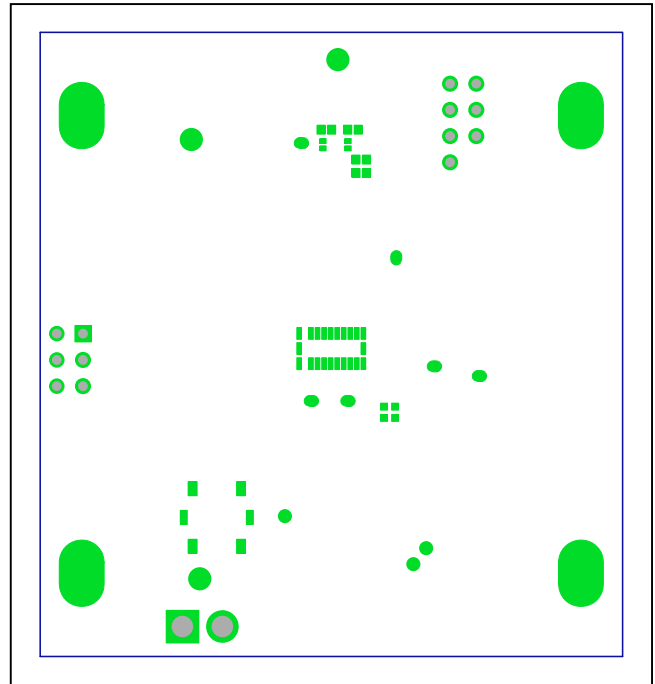

MAX86150 EV Kit—Top-Mask

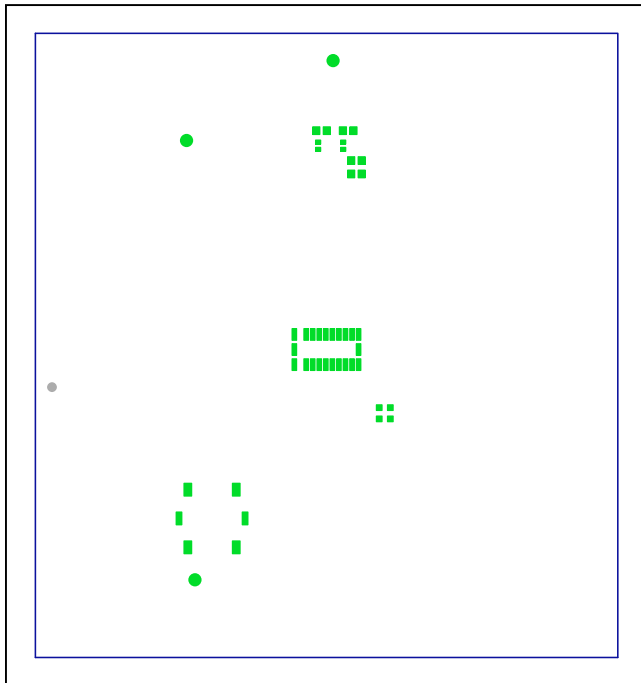

MAX86150 EV Kit—Top Pastemask

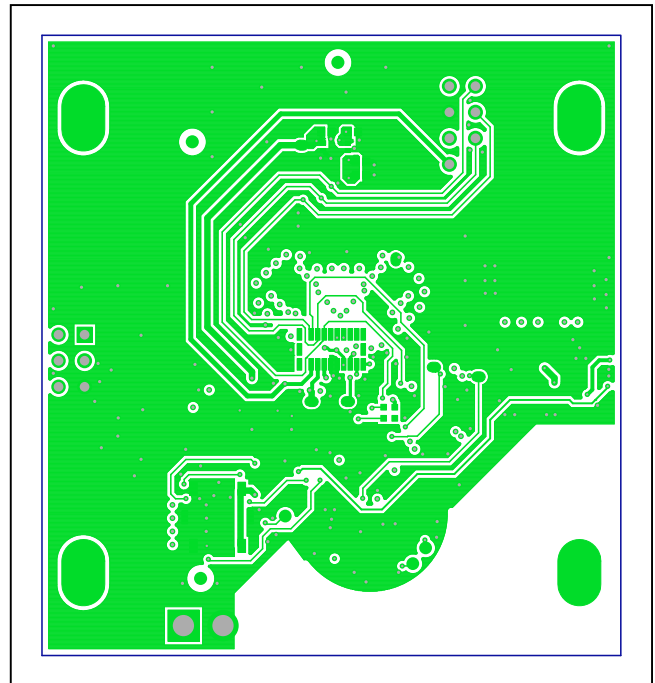

MAX86150 EV Kit—Level 1 Top

MAX86150 EV Kit PCB Layouts (continued)

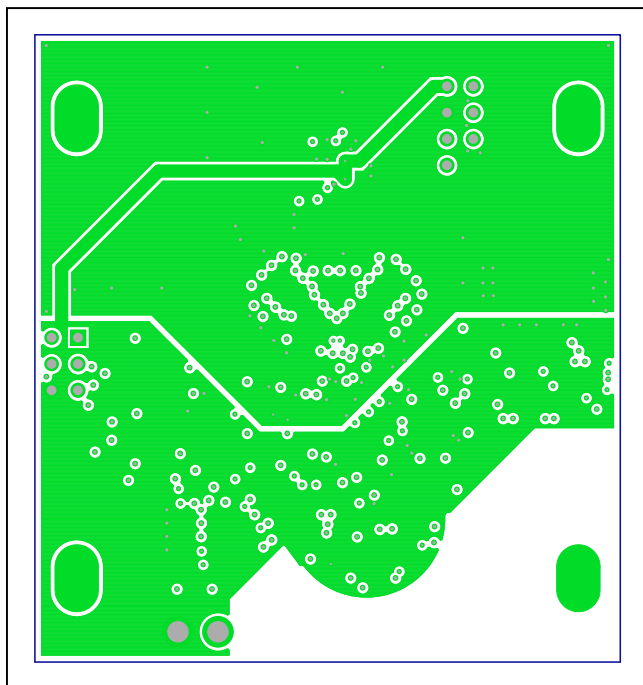

MAX86150 EV Kit—Level 2 Power

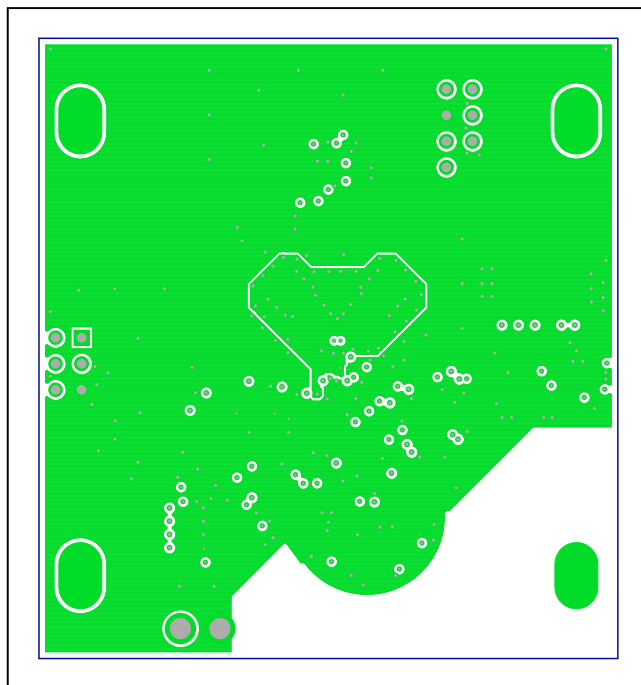

MAX86150 EV Kit—Level 3 Ground

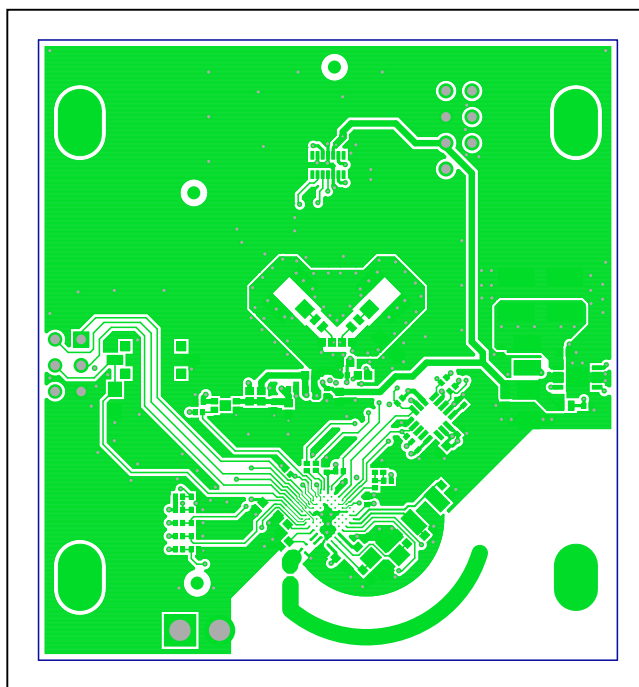

MAX86150 EV Kit—Level 4 Bottom

MAX86150 EV Kit PCB Layouts (continued)

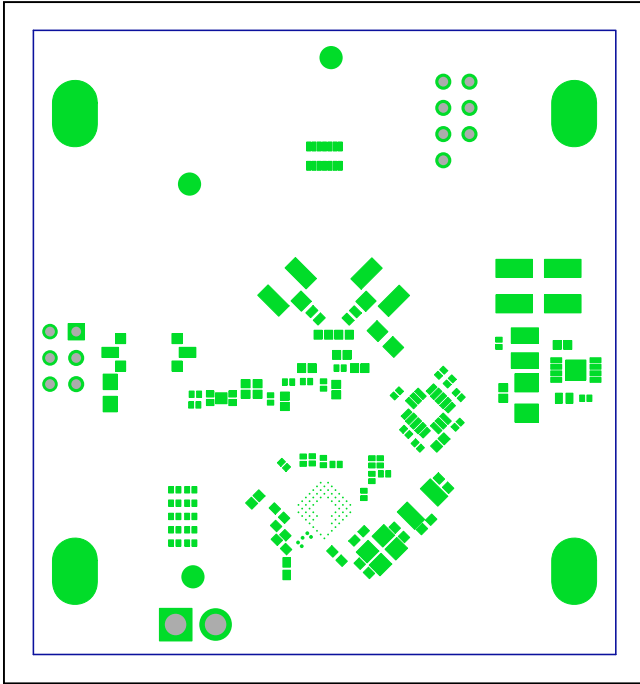

MAX86150 EV Kit—Bottom Mask

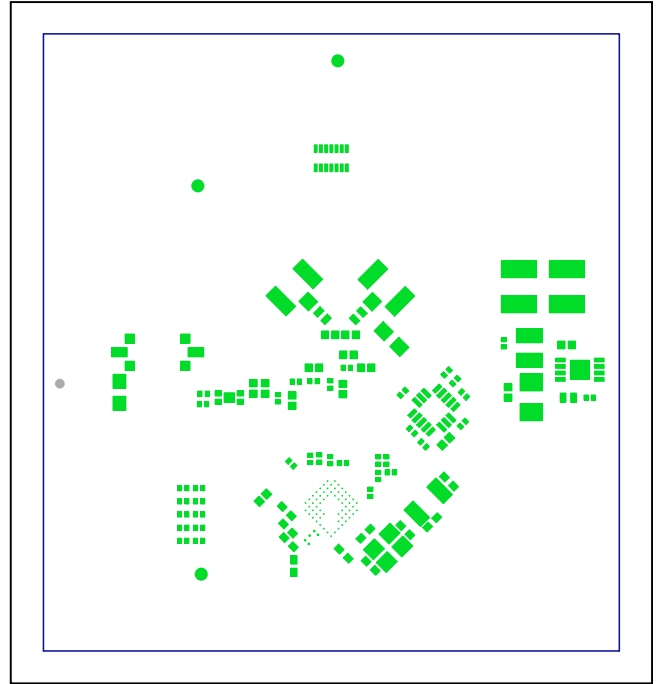

MAX86150 EV Kit—Bottom Pastemask

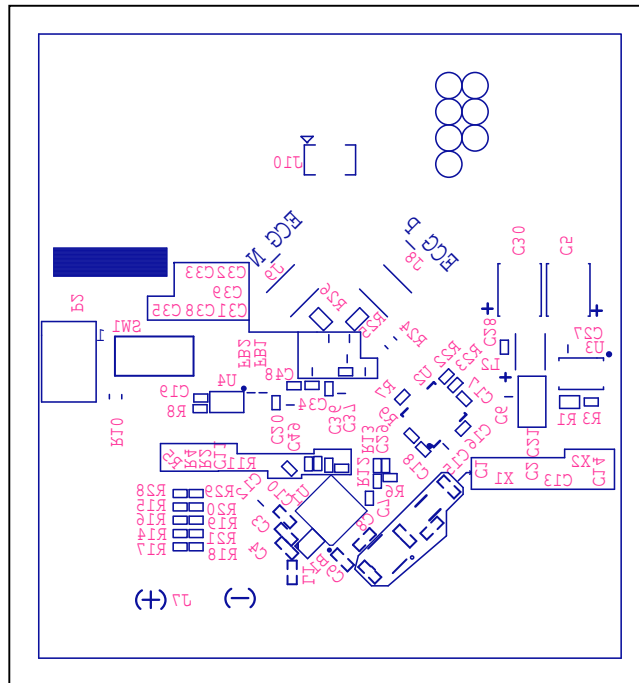

MAX86150 EV Kit—Bottom Silkscreen

MAX86150 EV Kit PCB Layouts (continued)

NOTES:

- 1) FABRICATE BOARD PER IPC 4600C
- 2) HARDENED LAYERS
- 3) FINISHED BOARD THICKNESS TO BE 62 MIL(TOLERANCE +/- .10%)
- 4) MINIMUM PLATING IN ALL THE THROUGH HOLES SHALL BE 0.001 INCH Cu.
- 5) ALL HOLES ARE PLATED THROUGH UNLESS OTHERWISE SPECIFIED.
- 6) HOLE SIZE ARE FINISHED SIZE.
- 7) SOLDER MASK BOTH SIDE WITH GREEN LIQUID PHOTO IMAGABLE.
- 8) SILKSCREEN BOTH SIDE "WHITE EPOXY" OVER SOLDER MASK
- 9) DEBURR ALL SHARP EDGES NOT EXCEED 0.007" PER INCH.
- 10) PLATING: IMMERSION GOLD FINISH
- 11) PLATING: IMMERSION GOLD FINISH
- 12) CLIP SILKSCREEN UNDER NO MASK AREA
- 13) USE +/-2MILS TOLERANCE FOR 30MIL PLATED THROUGH HOLES.
- 14) ALL OTHER PLATED THRU HOLES ARE +/- .3 MILS TOLERANCE
- 15) ADD FIDUCIAL MARKS ON THE PANELS WHEN PANELIZING THE BOARDS.
- 16) ROUTE THE BOARD OUTLINES AS PER GREENS
- 17) ROUTE THE BOARD OUTLINES AS PER GREENS
- 18) FAB HOLES SHOULD NOT MODIFY ANYTHING ON THIS AREA ON BOTTOM SIDE OF THE BOARD.
- 19) THIS AREA SHOULD BE FREE OF SILK OR ANY FAB NAME \ NUMBER ON ETCH - ON BOTTOM SIDE.
- 20) NO IMPEDANCE REQUIRED
- 21) ALL 0.008" & 0.010" PLATED HOLES NEED TO BE NON CONDUCTIVE FILLED AND PLATED OVER, IT SHOULD BE SMOOTH AND FLAT ON BOTH THE SIDES. "

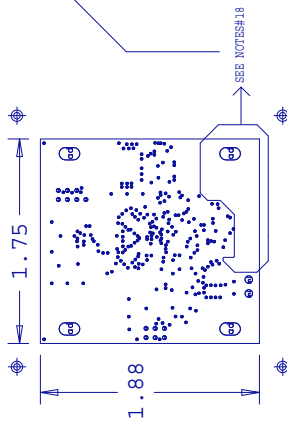
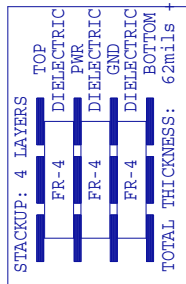

DRILL CHART: TOP to BOTTOM			
ALL UNITS ARE IN MILS			
FIGURE	SIZE	TOLERANCE	QTY
•	8.0	+3.0/-3.0	PLATED 44
•	10.0	+3.0/-3.0	PLATED 218
•	30.0	+4.0/-2.0	PLATED 13
•	65.0	+3.0/-3.0	PLATED 2
⊕	175.0x105.0	+2.0/-2.0	NON-PLATED 4

Revision History

REVISION NUMBER	REVISION DATE	DESCRIPTION	PAGES CHANGED
0	4/17	Initial release	—
1	11/17	Updated <i>Ordering Information</i> and <i>General Description</i>	1, 10

For pricing, delivery, and ordering information, please contact Maxim Direct at 1-888-629-4642, or visit Maxim Integrated's website at www.maximintegrated.com.

Maxim Integrated cannot assume responsibility for use of any circuitry other than circuitry entirely embodied in a Maxim Integrated product. No circuit patent licenses are implied. Maxim Integrated reserves the right to change the circuitry and specifications without notice at any time.