

## EMILY-WWW

~60° wide beam. 13.43 mm high lens. Modified version to fit CREE XM-L LEDs.

### TECHNICAL SPECIFICATIONS:

Dimensions	Ø 26 mm
Height	13.4 mm
Fastening	tape
Colour	clear
Box size	480 x 280 x 300 mm
Box weight	8.9 kg
Quantity in Box	1690 pcs
ROHS compliant	yes ⓘ



### MATERIAL SPECIFICATIONS:

Component	Type	Material	Colour
EMILY-WWW	Lens	PMMA	clear
SPUTNIK-TAPE	Tape	PU tape	black

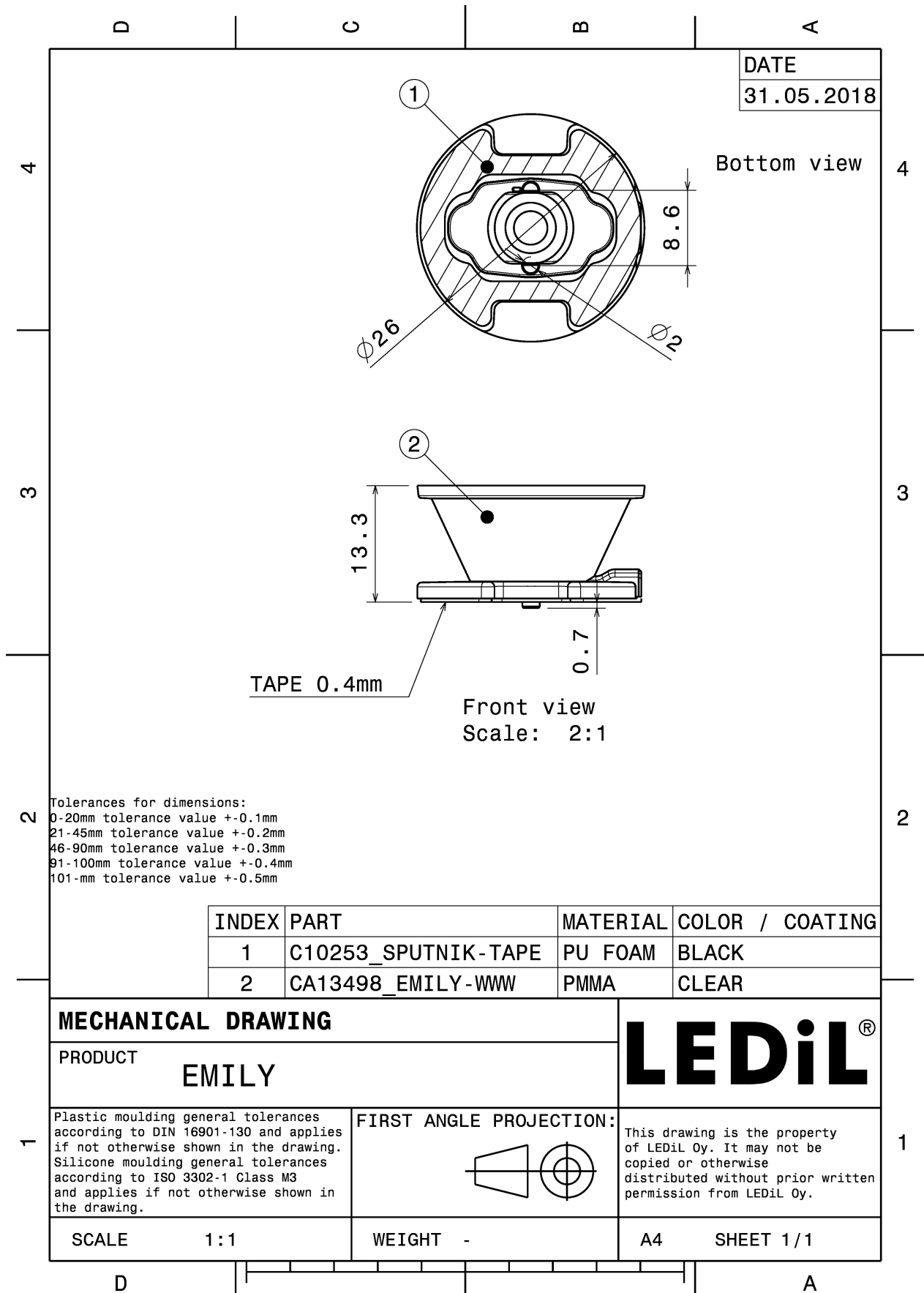

### PHOTOMETRIC DATA (MEASURED):

**CREE** 

LED XHP35 HD  
FWHM 70.0°  
Efficiency 84 %  
Peak intensity 0.700 cd/lm  
Required components:

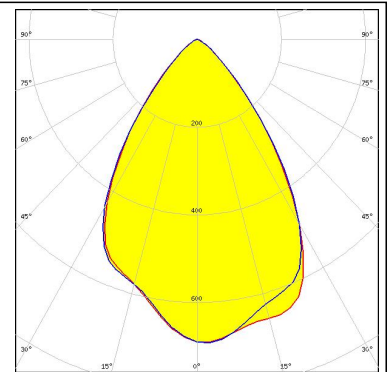

**CREE** 

LED XM-L  
FWHM 70.0°  
Efficiency 90 %  
Peak intensity 0.700 cd/lm  
Required components:

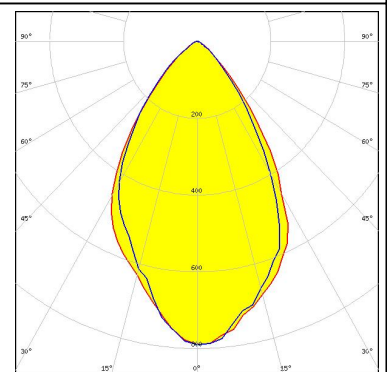
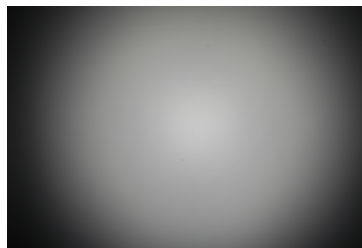

**CREE** 

LED XM-L2  
FWHM 70.0°  
Efficiency 88 %  
Peak intensity 0.700 cd/lm  
Required components:

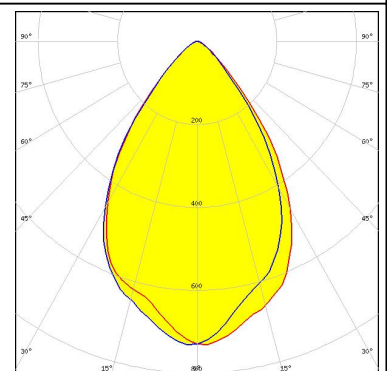
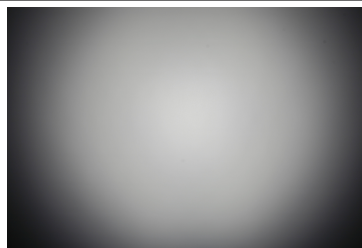

**CREE** 

LED XP-G3  
FWHM 64.0°  
Efficiency 93 %  
Peak intensity 0.820 cd/lm  
Required components:

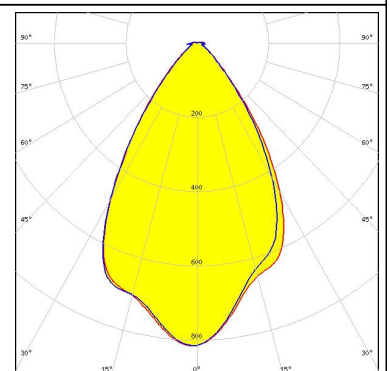
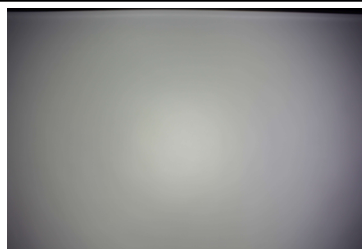

### PHOTOMETRIC DATA (MEASURED):

**CREE** 

LED XP-L  
FWHM 66.0°  
Efficiency 83 %  
Peak intensity 0.710 cd/lm  
Required components:

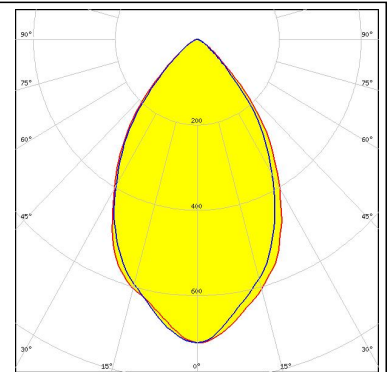
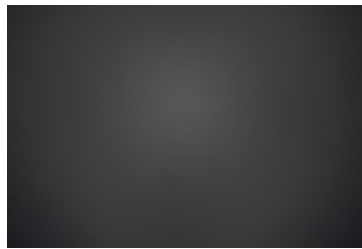

**CREE** 

LED XP-L HI  
FWHM 67.0°  
Efficiency 88 %  
Peak intensity 0.760 cd/lm  
Required components:

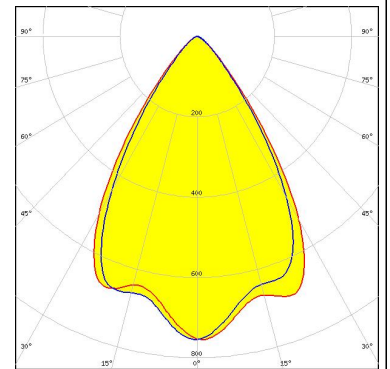
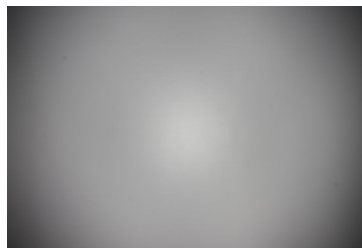

## GENERAL INFORMATION:

NOTE: The typical beam angle will be changed by different color, chip size and chip position tolerance. The typical total beam angle is the full angle measured where the luminous intensity is half of the peak value.

## MATERIALS:

As part of our continuous research and improvement processes, and to ensure the best possible quality and availability of our products, LEDiL reserves the right to change material grades without notice.

## PRODUCT DATA USER AGREEMENT AND DISCLAIMER:

The measured data in the provided downloadable LEDiL Product Datasheets and Mechanical 2D-Drawings is rounded and provided as reference for planning. LEDiL Oy's optical specifications have been verified by conducting performance testing of the products in accordance with the company's quality system. The reported data are averaged results of multiple measurements with typical variation. LEDiL Oy reserves the right to without prior notification make changes and improvements to its products.

LEDiL Oy assumes neither warranty, nor guarantee nor any other liability of any kind for the contents and correctness of the provided data. The provided data has been generated with highest diligence but the provided data may in reality not represent the complete possible variation range of all intrinsic parameters. Therefore, in certain cases a deviation from the provided data could occur.

LEDiL Oy reserves the right to undertake technical changes of its products without further notification which could lead to changes in the provided data. LEDiL Oy assumes no liability of any kind for the possible deviation from any provided data or any other damage resulting from the usage of the provided data.

The user agrees to this disclaimer and user agreement with the download or usage of the provided files.

### LEDiL Oy

Joensuunkatu 13  
FI-24240 SALO  
Finland

### LEDiL Inc.

228 West Page Street  
Suite D  
Sycamore IL 60178  
USA

### Local sales and technical support

[www.ledil.com/  
where\\_to\\_buy](http://www.ledil.com/where_to_buy)

### Shipping locations

Salo, Finland  
Hong Kong, China

### Distribution Partners

[www.ledil.com/  
where\\_to\\_buy](http://www.ledil.com/where_to_buy)