

SPECIFICATION

Patent Pending

- Part No. : **FXUB71.A.07.C.001**
- Product Name : Embedded Flexible 4G LTE MIMO 2*2 Antenna with 150mm 1.37 IPEX MHFI (U.FL) 698 MHz to 3GHz
- Features : Worldwide LTE Functionality with 3G and 2G (HSPA / GSM / CDMA /DCS /PCS / WCDMA / UMTS / GPRS / EDGE / GPS / 2.4GHz Wi-Fi) 240mm*21mm*0.15mm 150mm Φ 1.37 Coaxial cable I-PEX MHFI HT (U.FL compatible) Connector 3M Adhesive Tape for Peel and Stick Mounting Cable and connector are customizable

RoHS Compliant

Photo:

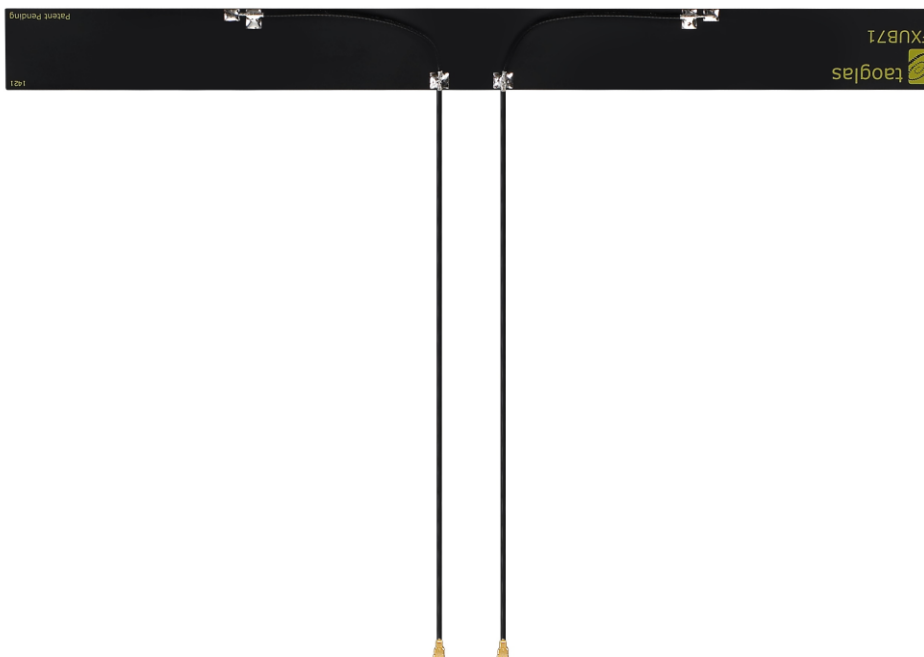

1. Introduction

The patent pending FXUB71 antenna is an industry leading embedded LTE 2*2 MIMO flexible polymer monopole type antenna for worldwide LTE applications, which also works equally well on 3G and 2G applications. The antenna comes with a micro coax cable and connector, and has good efficiency and isolation between ports, critical for optimal LTE wireless performance.

Typical applications

- LTE Gateways and Routers
- High speed HD streaming
- LTE Access Points
- High capacity MIMO networks for Public Transportation

With over 40% efficiency on all bands, isolation performance between the two ports is under -10dB in all bands. The antenna has been designed in a slim rectangular form-factor, with its own automotive quality 3M 467 adhesive backing tape, to ensure good isolation and convenient installation into typical M2M/IOT devices. Simply peel and stick onto your plastic housing.

The antenna is tuned to work on a reference ABS plastic of 2mm of thickness which is a common standard for most device plastics. Cable routing has been carefully planned to ensure no cross-over of cable, and a logical and hassle free installation. Like all such antennas, care should be taken to mount the antenna at least 10mm from metal components or surfaces, and ideally 20mm for best radiation efficiency.

Before integration of the antenna in your device, especially if you require PTCRB or US network approvals, please contact Taoglas regional sales office for technical support.

Cable length and connector type are fully customizable.

2. Specification

ELECTRICAL										
Standard	LTE 700MHz	850 MHz	900MHz	GPS/GLO NASS	DCS	PCS	WCDMA I/UMTS	Wi-Fi	LTE	LTE
Frequency (MHz)	703~803	824~894	880~960	1565~16 12	1710~18 80	1850~19 90	1920~21 70	2400~25 00	2500~27 00	3400~36 00
Efficiency (%)										
MIMO 1	50.48	61.60	50.51	76.22	83.31	76.00	72.86	65.55	62.25	56.93
MIMO 2	52.83	59.36	52.90	77.38	82.85	75.06	74.71	63.25	63.56	61.93
Average Gain(dBi)										
MIMO 1	-2.98	-2.11	-3.00	-1.18	-0.81	-1.19	-1.39	-1.84	-2.12	-2.45
MIMO 2	-2.77	-2.27	-2.78	-1.12	-0.83	-1.24	-1.27	-1.99	-2.01	-2.08
Peak Gain(dBi)										
MIMO 1	0.97	1.26	0.54	2.81	3.85	3.72	4.23	3.95	3.62	2.93
MIMO 2	1.43	1.21	0.54	2.51	4.01	4.42	4.72	4.31	3.24	3.11
Impedance						50Ω				
Polarization						Linear				
Radiation Pattern						Omni-directional				
Input Power						2 W Max.				
MECHANICAL										
Antenna Dimensions						240mm X 21mm X 0.15mm				
Antenna Body Material						Polymer				
Cable						2* Black Φ1.37 Coaxial cable				
Cable Length						2*150mm				
Connector						I-PEX MHFHT				
Weight						5g				
ENVIRONMENTAL										
Temperature Range						-40° C to 85° C				
Storage Temperature						-40° C to 85° C				
Humidity						Non-condensing 65° C 95% RH				

LTE BANDS				
Band Number	LTE / LTE-Advanced / WCDMA / HSPA / HSPA+ / TD-SCDMA			
	Uplink	Downlink	MIMO 1	MIMO 2
1	UL: 1920 to 1980	DL: 2110 to 2170	✓	✓
2	UL: 1850 to 1910	DL: 1930 to 1990	✓	✓
3	UL: 1710 to 1785	DL: 1805 to 1880	✓	✓
4	UL: 1710 to 1755	DL: 2110 to 2155	✓	✓
5	UL: 824 to 849	DL: 869 to 894	✓	✓
7	UL: 2500 to 2570	DL: 2620 to 2690	✓	✓
8	UL: 880 to 915	DL: 925 to 960	✓	✓
9	UL: 1749.9 to 1784.9	DL: 1844.9 to 1879.9	✓	✓
11	UL: 1427.9 to 1447.9	DL: 1475.9 to 1495.9	✗	✗
12	UL: 699 to 716	DL: 729 to 746	✓	✓
13	UL: 777 to 787	DL: 746 to 756	✓	✓
14	UL: 788 to 798	DL: 758 to 768	✓	✓
17	UL: 704 to 716	DL: 734 to 746 (LTE only)	✓	✓
18	UL: 815 to 830	DL: 860 to 875 (LTE only)	✓	✓
19	UL: 830 to 845	DL: 875 to 890	✓	✓
20	UL: 832 to 862	DL: 791 to 821	✓	✓
21	UL: 1447.9 to 1462.9	DL: 1495.9 to 1510.9	✗	✗
22	UL: 3410 to 3490	DL: 3510 to 3590	✓	✓
23	UL: 2000 to 2020	DL: 2180 to 2200 (LTE only)	✓	✓
24	UL: 1625.5 to 1660.5	DL: 1525 to 1559 (LTE only)	✓	✓
25	UL: 1850 to 1915	DL: 1930 to 1995	✓	✓
26	UL: 814 to 849	DL: 859 to 894	✓	✓
27	UL: 807 to 824	DL: 852 to 869 (LTE only)	✓	✓
28	UL: 703 to 748	DL: 758 to 803 (LTE only)	✓	✓
29	UL: -	DL: 717 to 728 (LTE only)	✓	✓
30	UL: 2305 to 2315	DL: 2350 to 2360 (LTE only)	✓	✓
31	UL: 452.5 to 457.5	DL: 462.5 to 467.5 (LTE only)	✗	✗
32	UL: -	DL: 1452 - 1496	✗	✗
35		1850 to 1910	✓	✓
38		2570 to 2620	✓	✓
39		1880 to 1920	✓	✓
40		2300 to 2400	✓	✓
41		2496 to 2690	✓	✓
42		3400 to 3600	✓	✓
43		3600 to 3800	✗	✗

*Covered bands represent an efficiency greater than 20%

3. Antenna Characteristics

3.1. Testing setup



Figure.1 Test setup on the 2mm ABS

3.2. Return loss

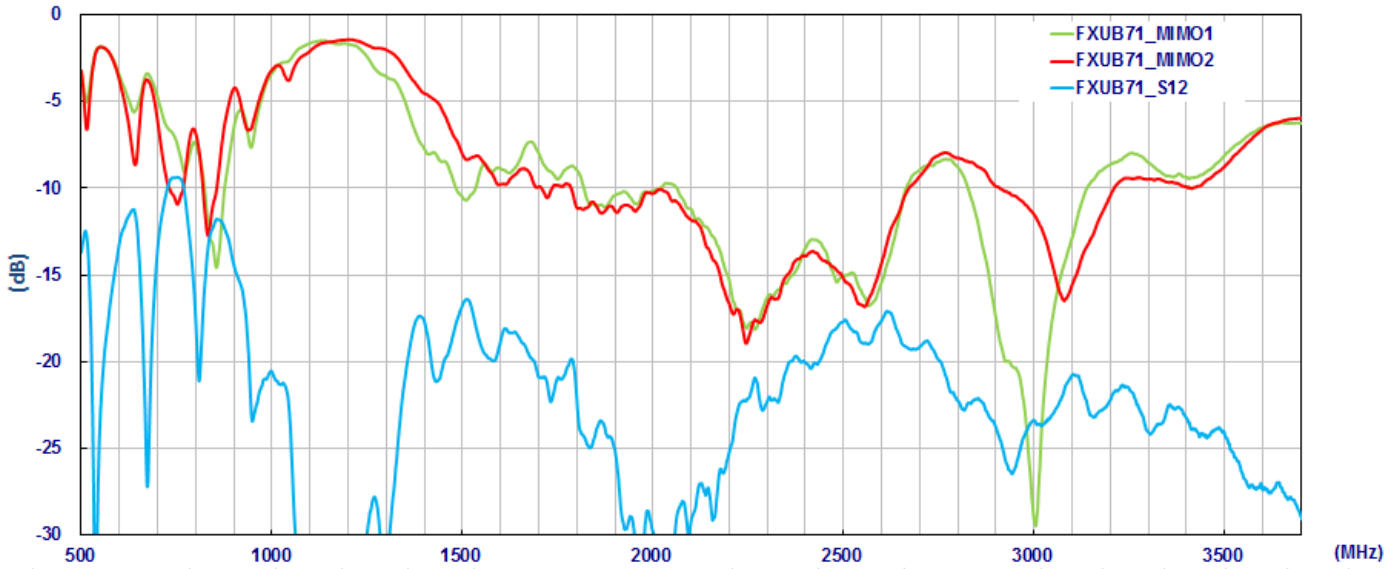

Figure2. Return loss with 150 mm cable length and on the 2mm ABS of FXUB71

3.3. Efficiency

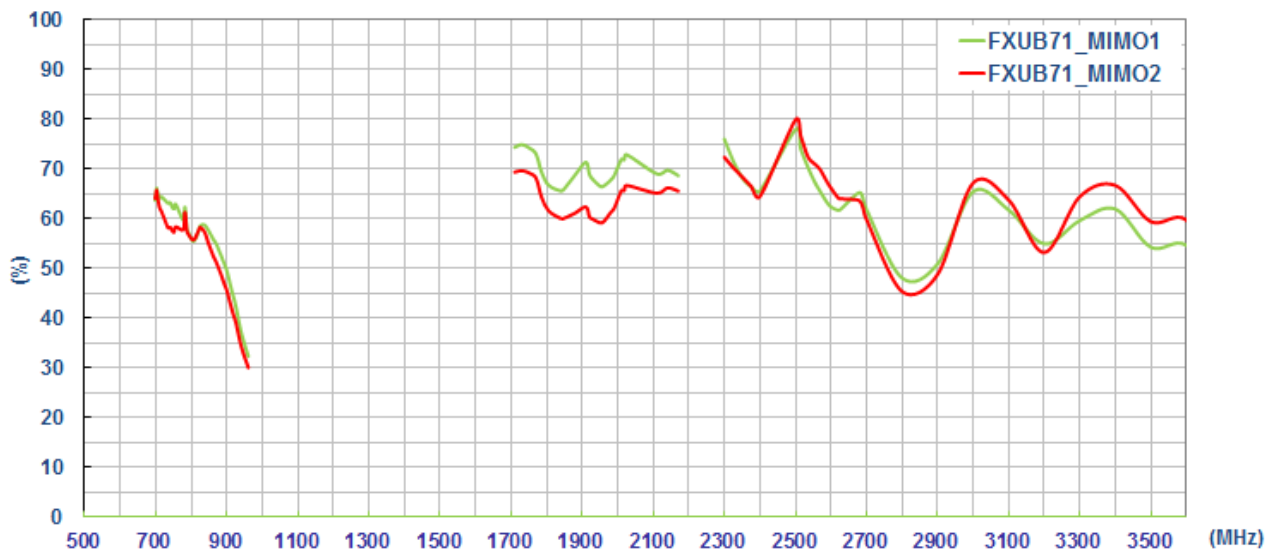

Figure3. Efficiency with 150 mm cable length and on the 2mm ABS of FXUB71

3.4. Peak gain

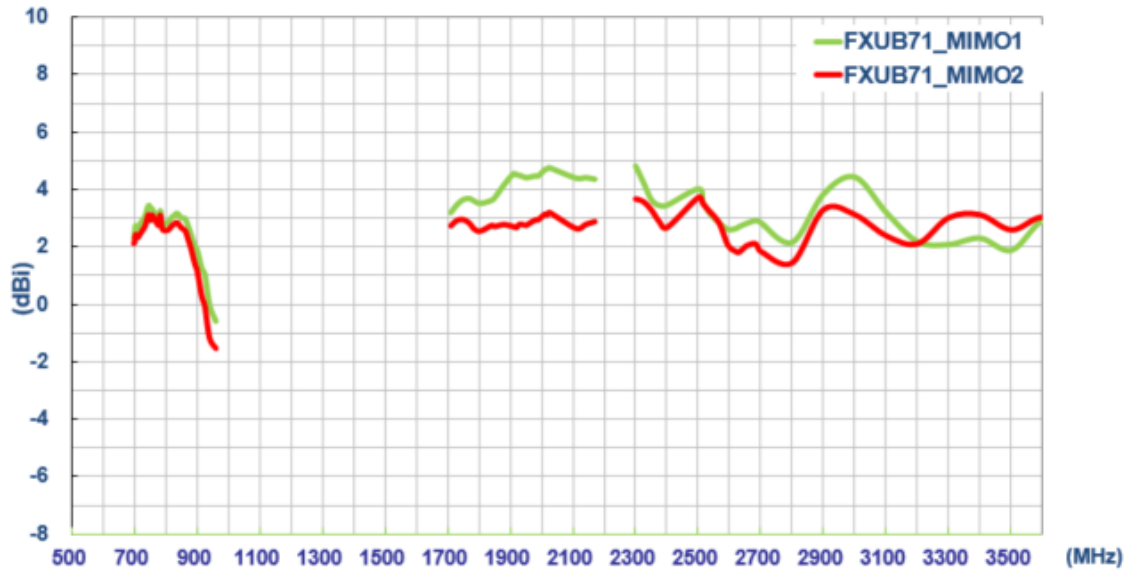

Figure4. Peak gain with 150 mm cable length and on the 2mm ABS of FXUB71

3.5. Average gain

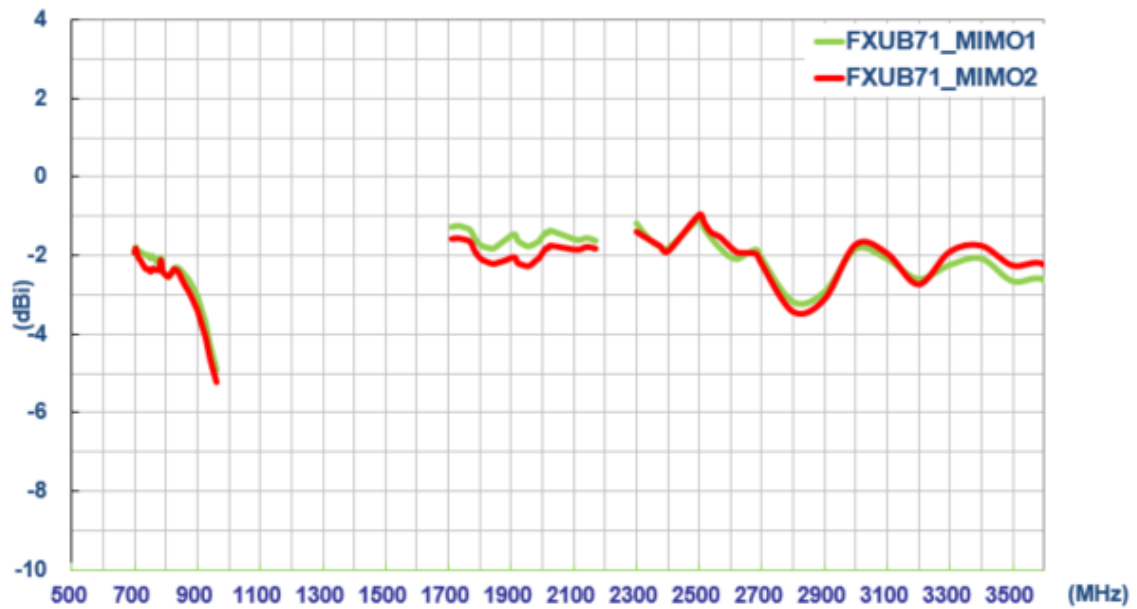
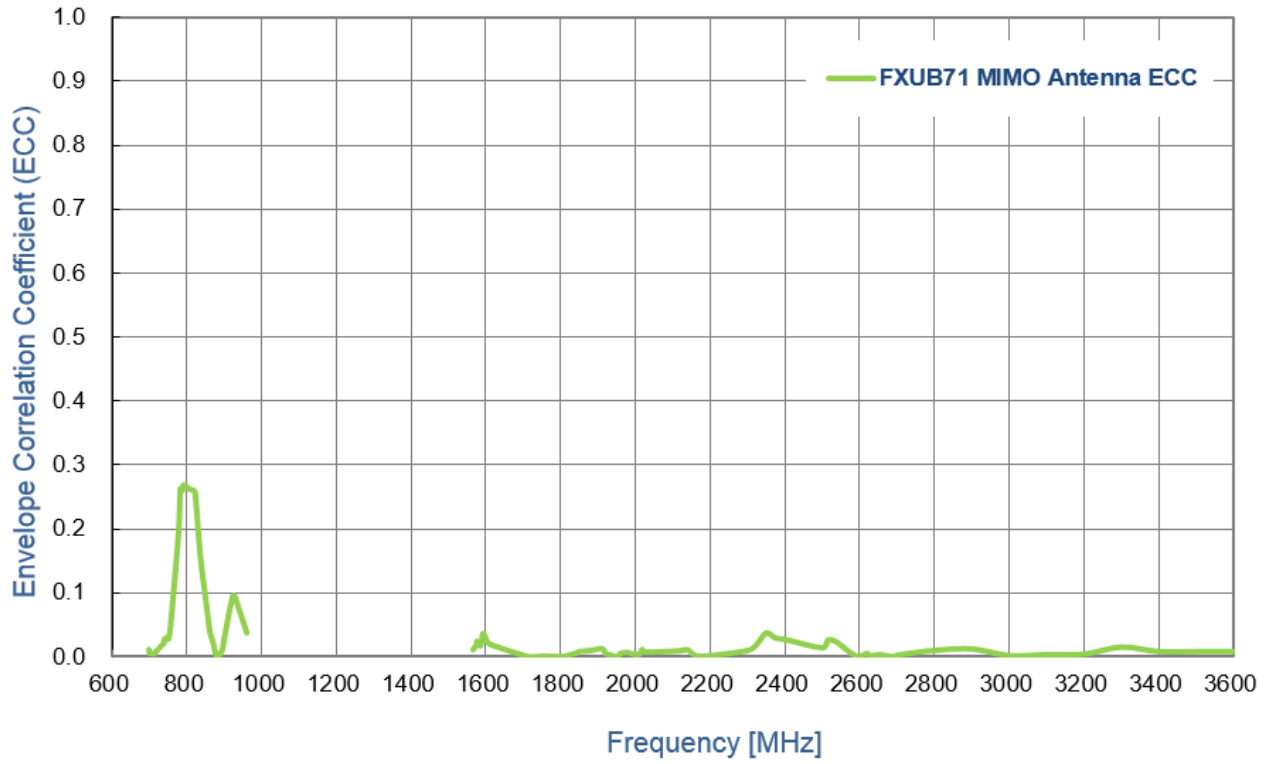

Figure5. Average gain with 150 mm cable length and on the 2mm ABS of FXUB71

3.6. Envelope Correlation Coefficient



4. Antenna Radiation Patterns

The antenna radiation patterns were measured in ETS Anechoic Chamber. The measurement setup as below,

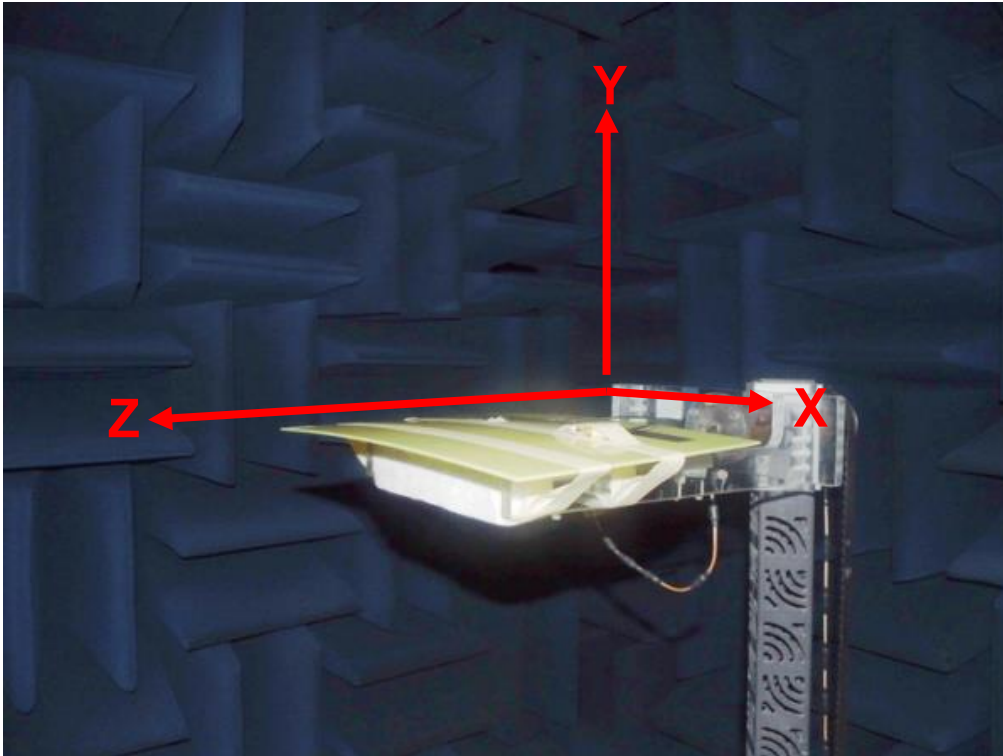
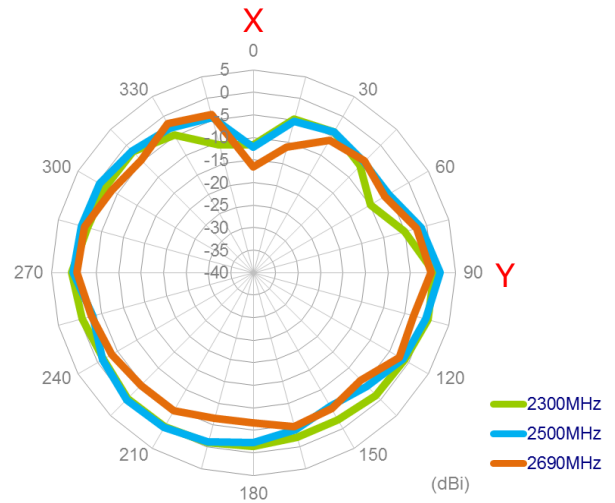
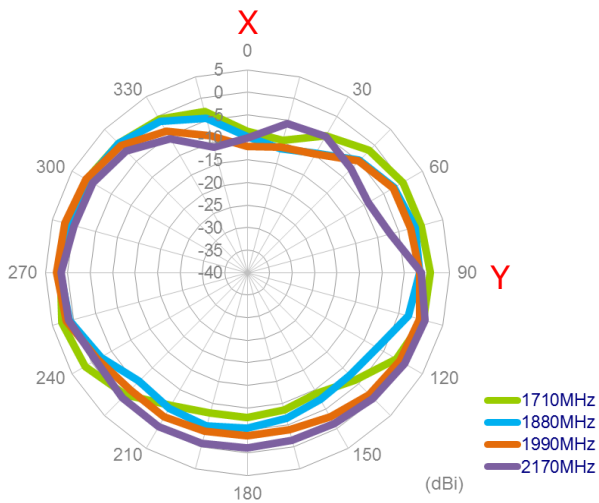
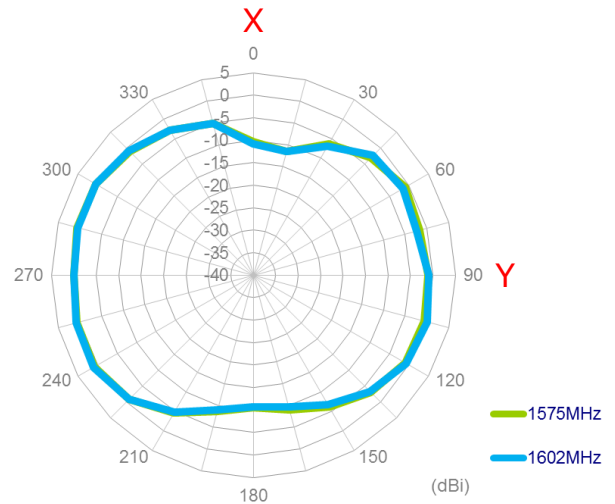
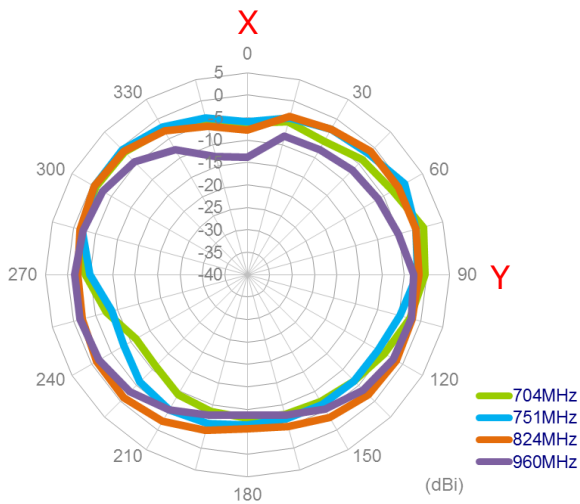

Figure.6 Testing Setup in ETS Anechoic Chamber

4.1. Antenna Radiation Patterns

4.1.1. Antenna with 150mm cable length and on the 2mm ABS

XY Plane MIMO 1



XY Plane MIMO 2

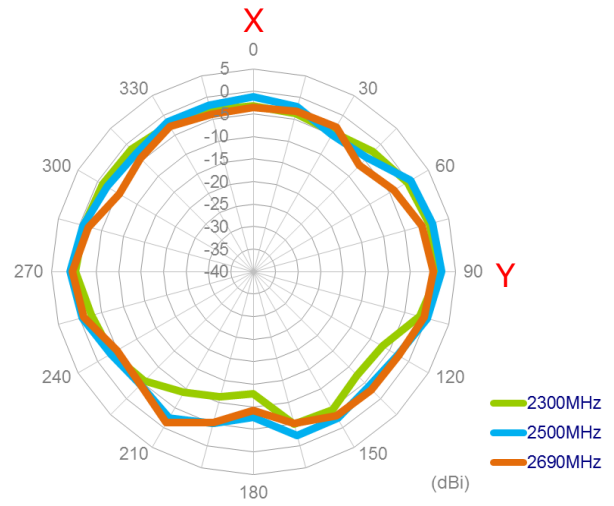
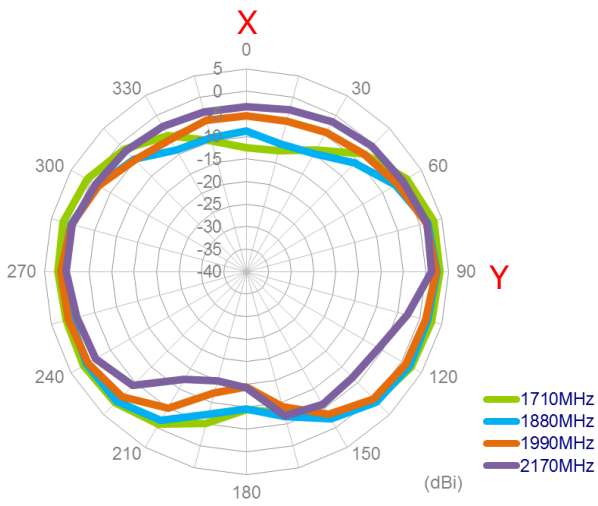
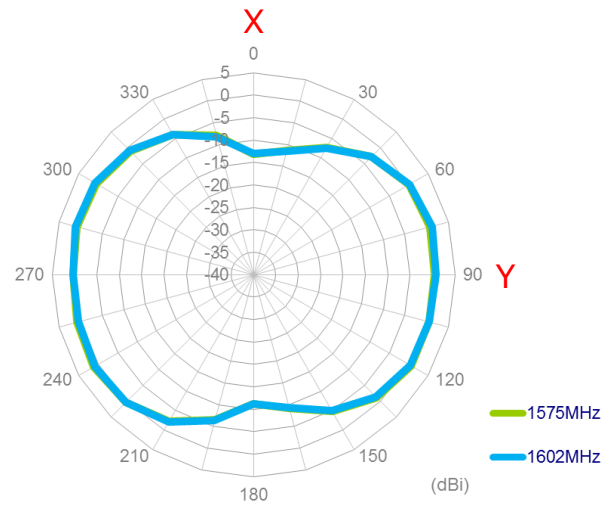
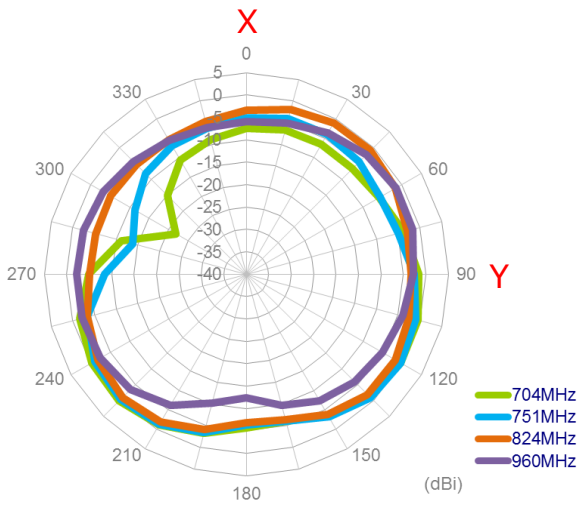

ZX Plane MIMO 1

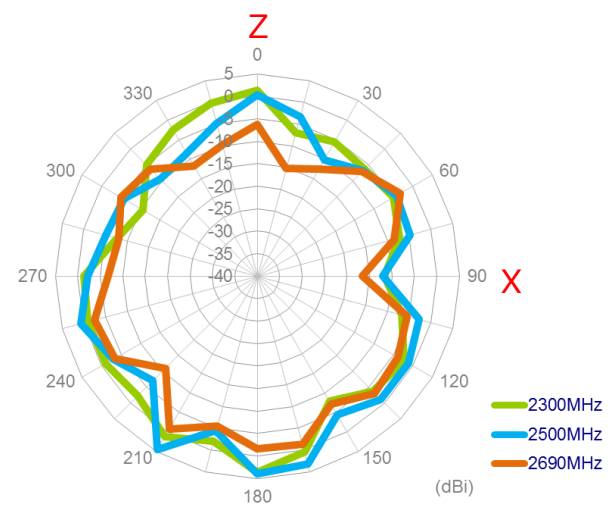
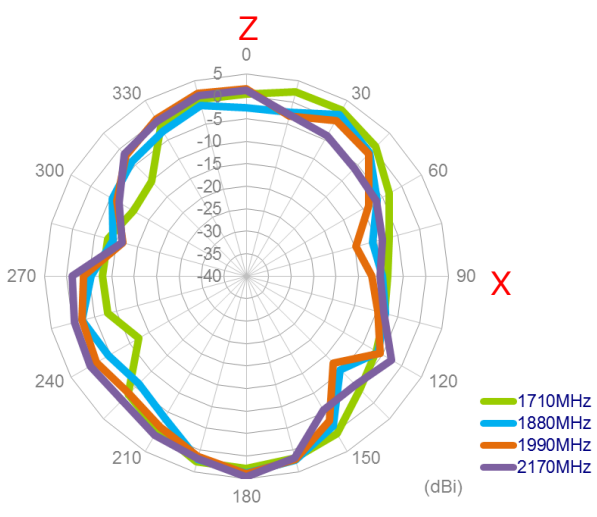
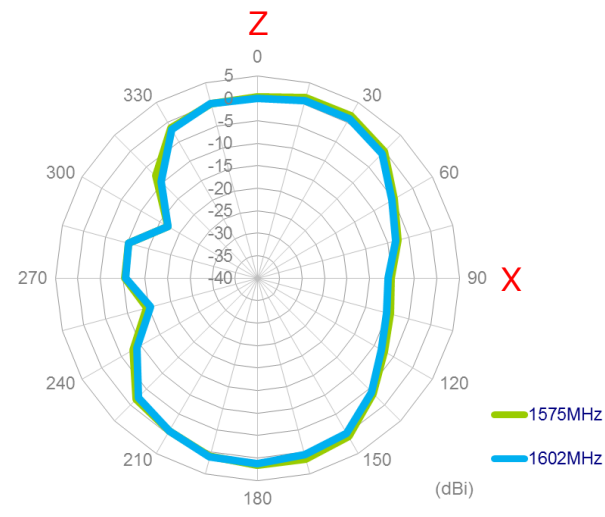
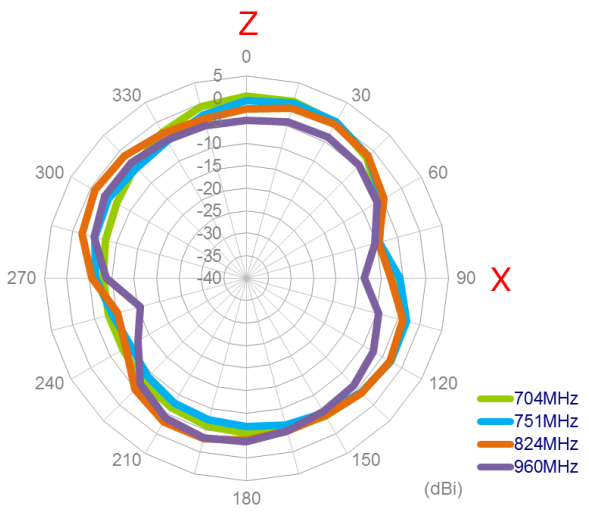

ZX Plane MIMO 2

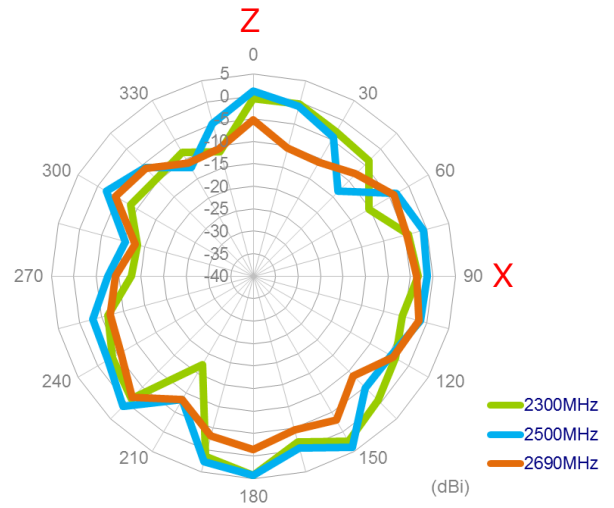
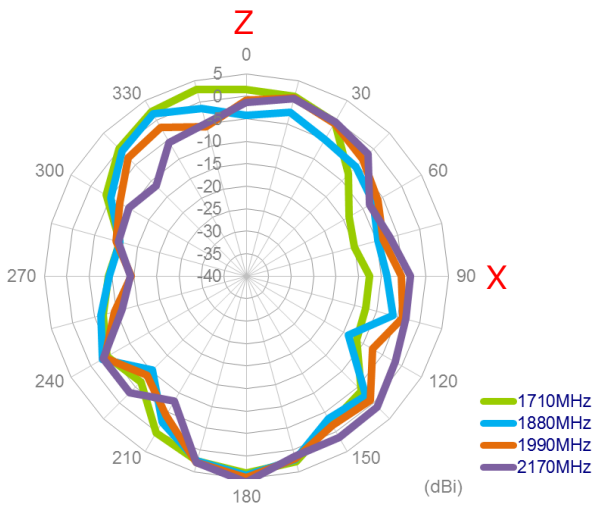
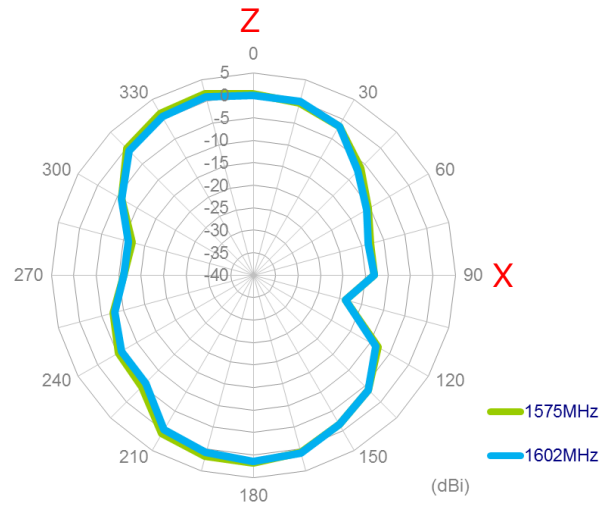
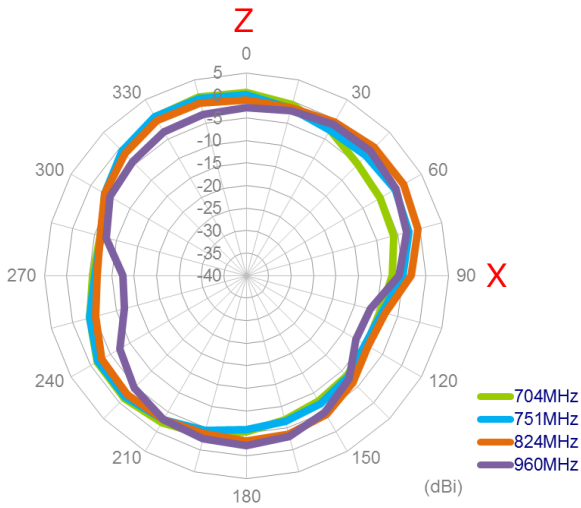

YZ Plane MIMO 1

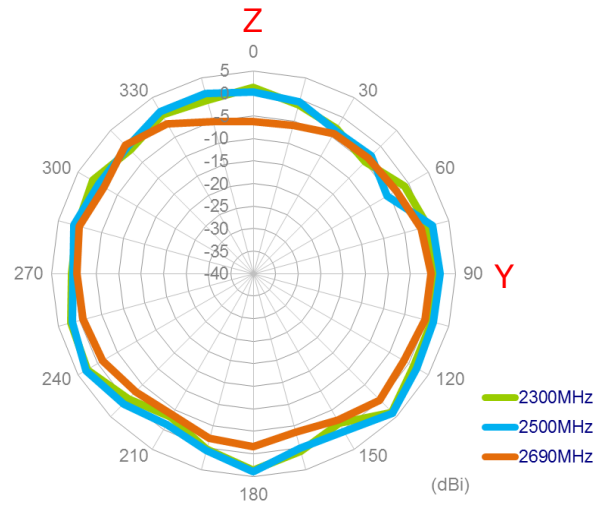
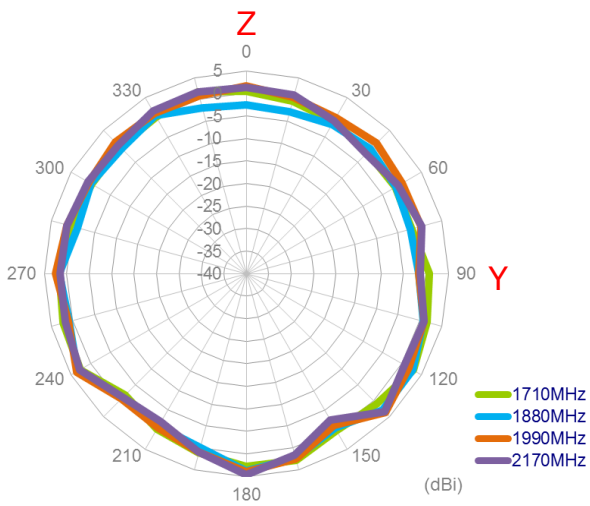
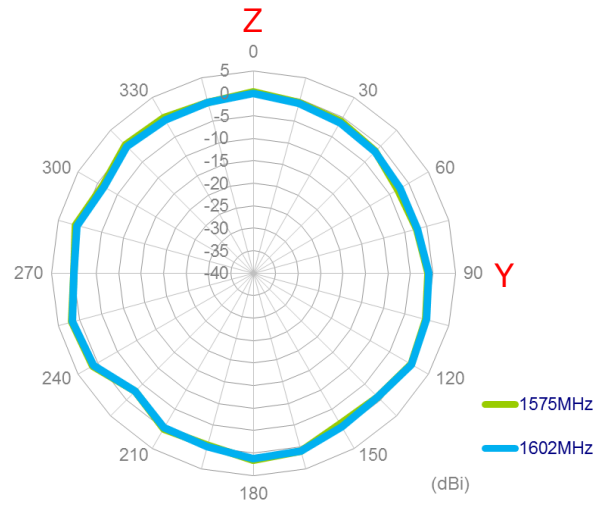
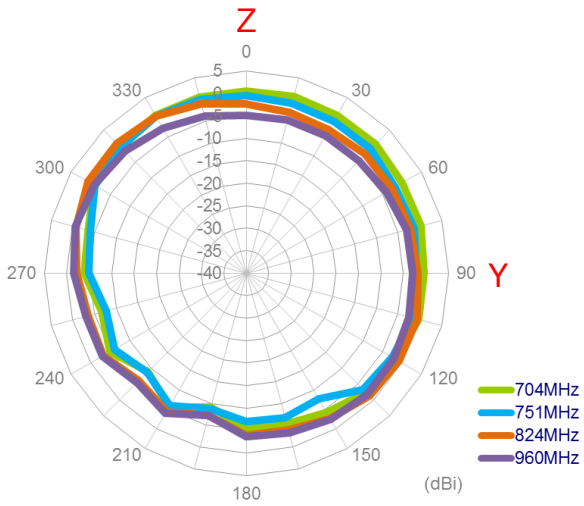

YZ Plane MIMO 2

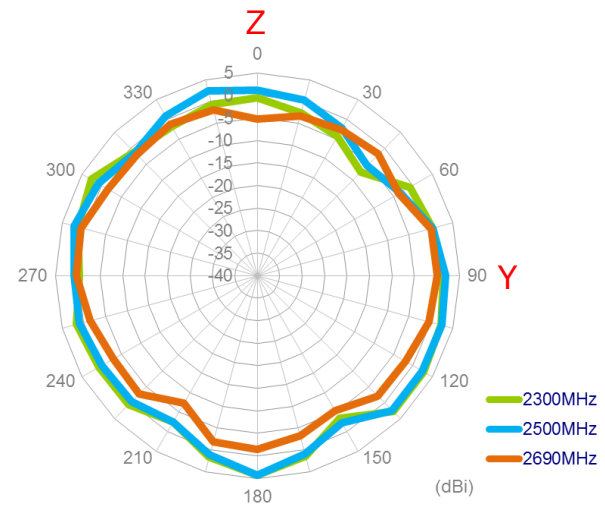
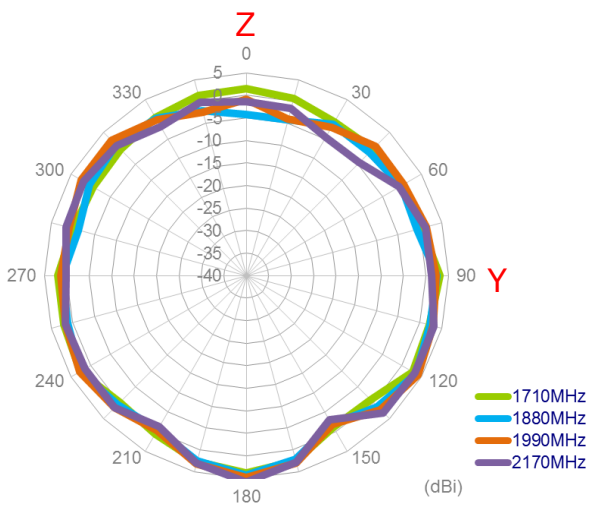
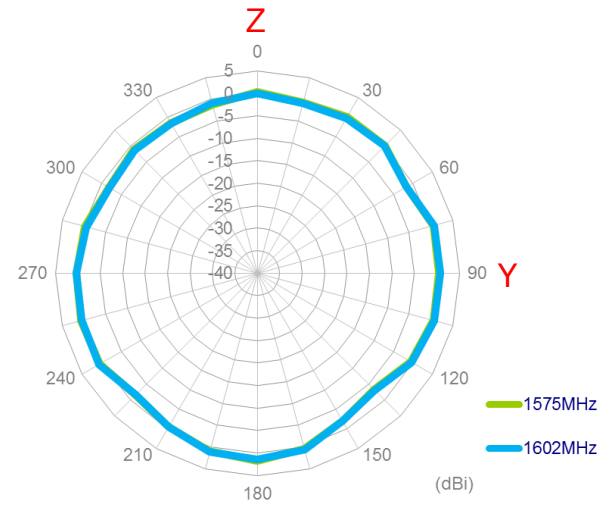
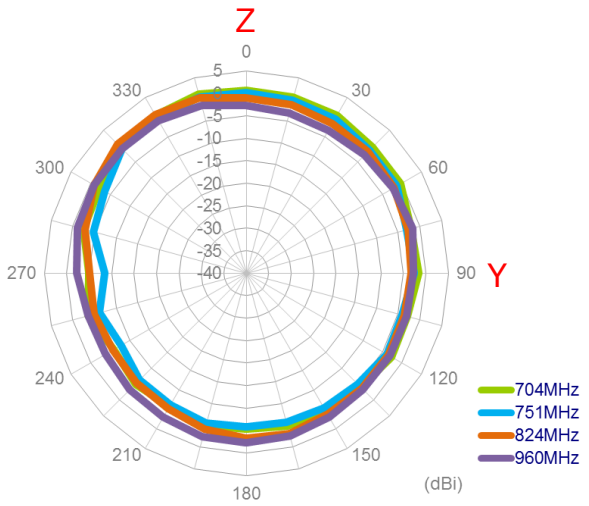

5. Mechanical Drawing

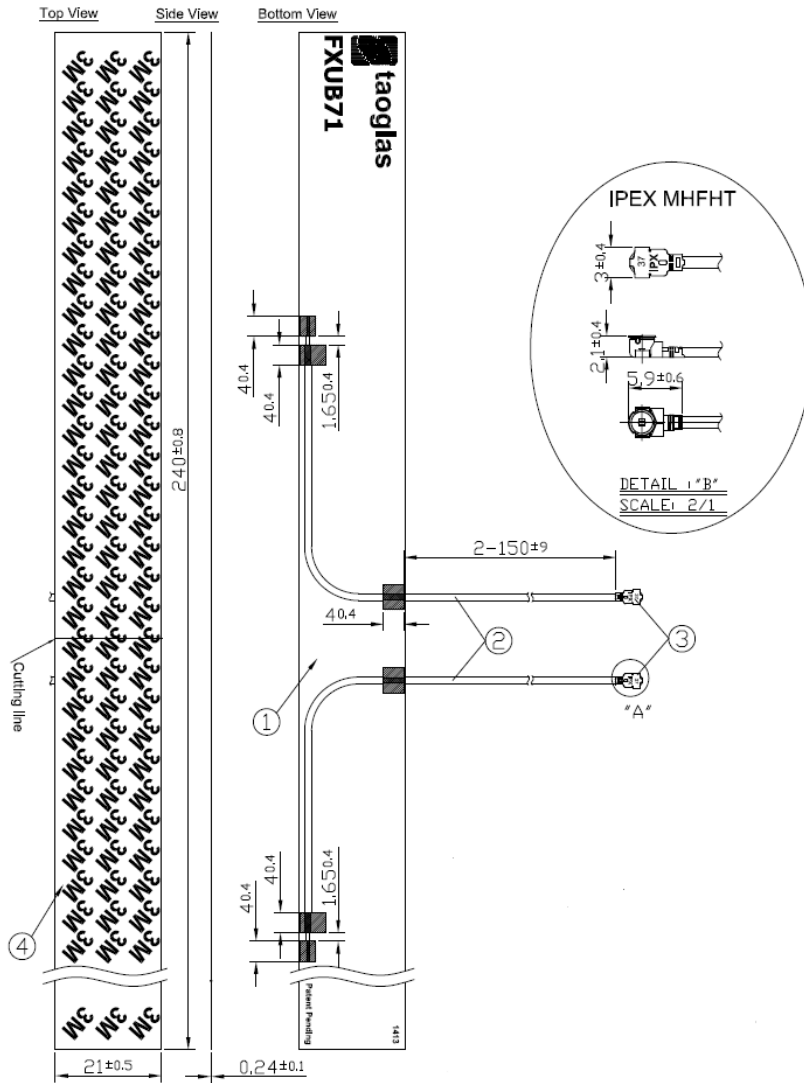

	Name	Material	Finish	QTY
1	FXUB71 FPCB	FPCB 0.15t	Black	1
2	1.37 Mini-Coaxial Cable	FEP	Black	2
3	IPEX MHFHT	Brass	Gold	2
4	Double-Sided Adhesive	3M 467	Liner	1

6. Packaging

FXUB71.A.07.C.001

Packaging Specifications

50 pcs FXUB71.A.07.C.001 per PE bag
 PE Bag Dimensions - 430 x 280mm
 Weight - 235.5g

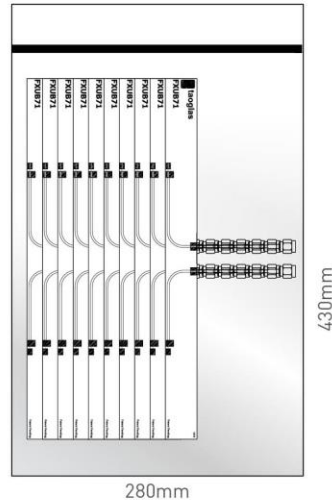

20 PE bags per carton
 1000 pcs FXUB71.A.07.C.001 per carton
 Carton Dimensions - 390*270*350 mm
 Weight - 5.4kg

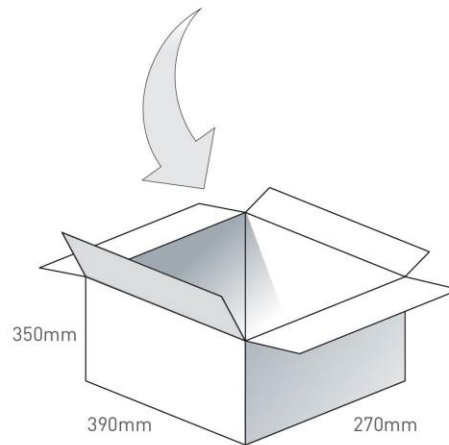

Pallet Dimensions 1200*1200*1000mm
 30 Cartons per Pallet
 10 Cartons per layer
 3 Layers

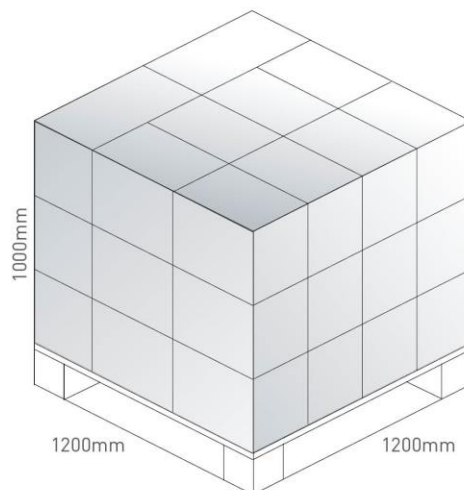

Taoglas makes no warranties based on the accuracy or completeness of the contents of this document and reserves the right to make changes to specifications and product descriptions at any time without notice. Taoglas reserves all rights to this document and the information contained herein.

Reproduction, use or disclosure to third parties without express permission is strictly prohibited.

Copyright © Taoglas Ltd.