

# Murata Supercapacitor Technical Note

Contents

1. Principle and structure of supercapacitor .	3	5.6. Current (Charge current and leakage current) .....	18
1.1. Principle .....	3	6. Reliability .....	20
1.2. Structure .....	3	6.1. Dry up failure .....	20
1.3. Equivalent circuit model .....	5	6.2. Aging degradation .....	21
2. Key features and your benefits .....	6	6.3. Charge/discharge cycle life .....	23
2.1. Key features and your benefits.....	6	6.4. Package bulging.....	23
2.2. High energy.....	8	6.5. How to consider reliability .....	25
2.3. High power.....	8	7. Technical supports .....	26
2.4. High reliability.....	9	7.1. Application notes .....	26
3. Supercapacitor solutions in your devices.	10	7.2. Simulation tools for degradation and performance .....	26
3.1. High peak load leveling .....	10	7.3. Simulation examples .....	27
3.2. High peak power function.....	10	7.4. Reliability report .....	29
3.3. High-power backup.....	11	7.5. Electrical circuit models and 3D schematics.....	29
3.4. Storage for energy harvest .....	12	8. Cautions for use .....	29
4. Lineup of Murata’s supercapacitors .....	12	8.1. Limitation to applications .....	29
4.1. High-power versatile type; DMT series	12	8.2. Polarity .....	30
4.2. Ultra high-power type; DMF series...	13	8.3. Temperature and self heating.....	30
5. Performance .....	14	8.4. Soldering and assembling .....	30
5.1. Capacitance.....	14	8.5. Fixation of supercapacitor .....	30
5.2. ESR .....	14	8.6. Response to IATA Dangerous Goods Regulations .....	31
5.3. Constant current discharge .....	15	9. Multiple connection of supercapacitors ...	31
5.4. Constant power discharge .....	16		
5.5. Temperature dependences (Cap, ESR, thickness) .....	17		

9.1. Parallel connection .....	31	11. Solder mounting method .....	36
9.2. Series connection .....	31	12. Safety .....	38
10. Voltage balance circuit .....	32	12.1. UL certification (UL 810A) .....	38
10.1. Passive balance control .....	32	12.2. Short circuit by any possibility .....	38
10.2. Active balance control .....	34	12.3. Self heating .....	38
10.3. Comparison between passive balance and active balance .....	35	13. FAQs.....	39

## 1. Principle and structure of supercapacitor

### 1.1. Principle

A supercapacitor is one of the highest-capacity capacitors. Supercapacitors (also called as Electrical Double Layer Capacitors (EDLCs)) don't have dielectric between positive and negative electrodes unlike ceramic capacitors or electrolytic capacitors. Instead, an electrolyte (solid or liquid) which has positive ions and negative ions is filled between the two electrodes (Fig. 1). An electrical state called "electrical double layer", which is a pair of electrons and positive ions or a pair of electric holes and negative ions which formed on surfaces of the electrodes, works as a dielectric and gives high capacitance.

Capacitance value of a supercapacitor is proportional to surface area of its electrodes. Therefore in order to get high capacitance, powdered activated carbons which have quite large surface area are used as an electrode material in many cases. A supercapacitor is charged by ions moving to the carbon surface. Conversely, it is discharged by ions moving away from the carbon surface (Fig. 2).

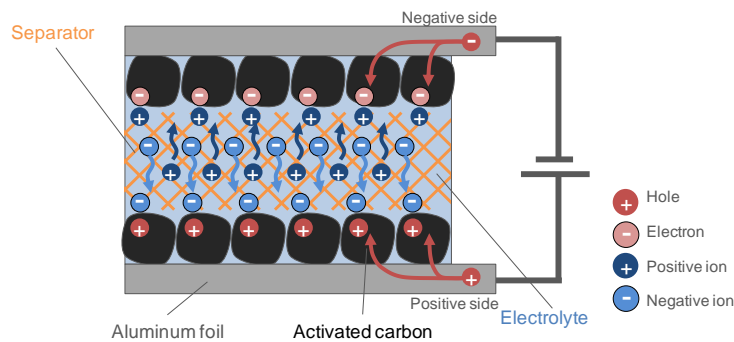

Fig. 1 Principle of supercapacitor

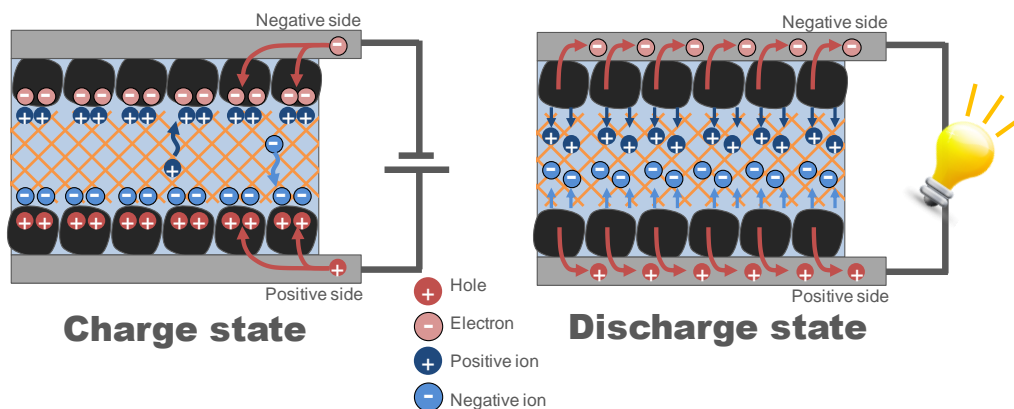

Fig. 2 Charge/discharge state in supercapacitor

### 1.2. Structure

In general, supercapacitors consist of positive electrode, negative electrode, electrolytic solution and

separator.

Structure of Murata’s supercapacitor is shown in Fig. 3, Fig. 4 and Fig. 5. The package is made from aluminum laminate film. Aluminum layer in the film can protect inner materials from outside circumstance (moisture and so on). The aluminum layer is coated by an insulating plastic layer on both surfaces of inner side and outer side for protection from short circuit.

Inner coating resin has also a function to seal package. The package is sealed around four sides by processing heat-sealing. Extracting leads are also sealed by the same process.

Murata’s supercapacitors have two unit cells (unit multilayered electrodes) in one package. A partition insulating film is placed between the two unit cells. An electrode sheet consists of an electricity collector and an activated-carbon layer (Fig. 5). Activated-carbon particles are printed on a surface of the electricity collector. Such multiple electrode sheets are layered with each sheet separated physically and electrically by separators (Fig. 5).

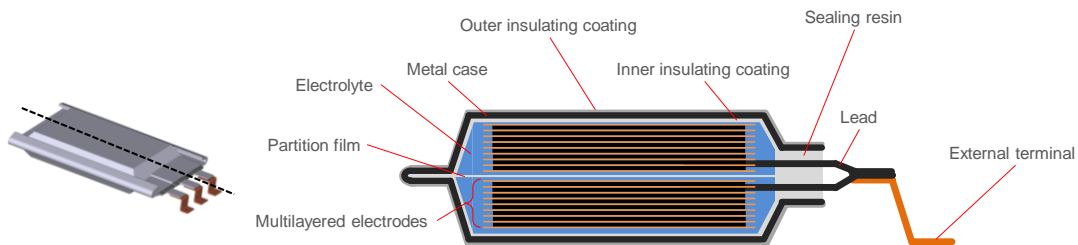

Fig. 3 Structure of Murata’s supercapacitor (LT cross section)

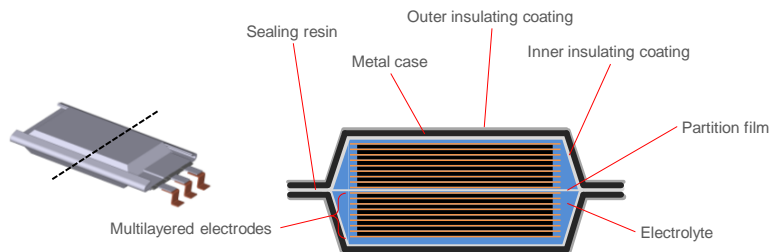

Fig. 4 Structure of Murata’s supercapacitor (WT cross section)

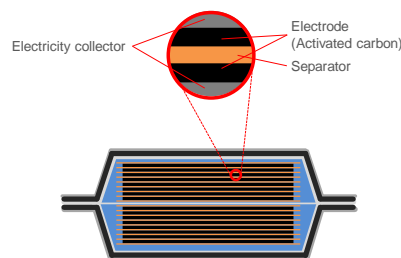

Fig. 5 Structure of Murata’s supercapacitor (Multilayered electrode)

1.3. Equivalent circuit model

In general, capacitors can be described by using combination of a capacitor (C), a series resistance ( $R_s$ ) and an insulation resistance ( $R_i$ ). Murata’s supercapacitors have two unit cells (unit capacitors) which are connected in series in one package. Therefore an equivalent circuit model is described as Fig. 6. The model can be combined to a simpler one such as Fig. 7. In this case, total capacitance value is equal to half of the unit cell and total resistance values are equal to two times of the unit cell.

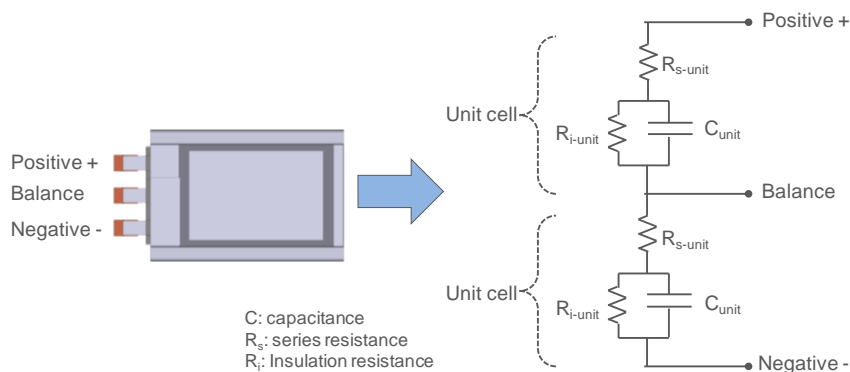

Fig. 6 Murata’s supercapacitor has two of unit cell in one package

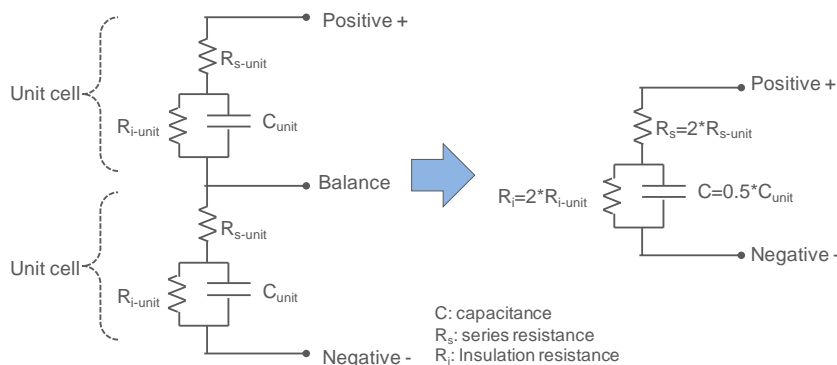

Fig. 7 Simple equivalent circuit model

However such model cannot reflect actual electrical behaviors of supercapacitors. This is because that an activated-carbon electrode has various-size pores on the surface. Electric charges are stored by ions moving to the porous electrode surface as mentioned in the section 1.1 (Fig. 2). They can move easily and quickly in shallow site of pores. On the other hand, they move very slowly in deep site due to physical resistance. It means that the shallow site can be fully-charged quickly but the deep site can be charged quite slowly (Fig. 8). For this reason, detailed equivalent model will be described with multiple parallel C and multiple series R as shown in Fig. 8. C and R in the deeper site has high values.

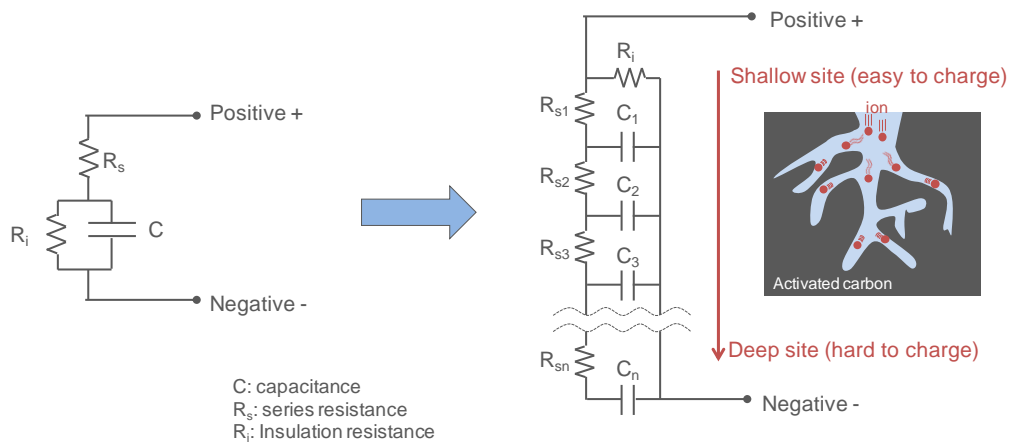

Fig. 8 Detailed equivalent circuit model

## 2. Key features and your benefits

### 2.1. Key features and your benefits

Murata’s supercapacitors have high capacitance values from several hundreds of millifarads to one farad and high rated voltages from 4.2 V to 5.5 V which are suitable for assistance of various batteries and high energy storages (Fig. 9).

Supercapacitors typically have higher energy density than other capacitors and higher power density than various batteries (Fig. 10). Especially Murata’s supercapacitors have higher power densities than other conventional supercapacitors in the market (Fig. 11) and they can discharge up to approx. 50 W. For this reason, Murata’s supercapacitors are suitable for high-peak load leveling, high-peak power function, high-power backup or storage for energy harvest.

Thicknesses in Murata’s supercapacitors are very thin from 2.2 mm to 3.7 mm. Therefore they can be embedded into various compact and slim devices. Another feature of Murata’s supercapacitors is the highest reliability among supercapacitors in the market. This is because our good package sealing prevents supercapacitor from outside moisture which causes degradation (see the section 2.4).

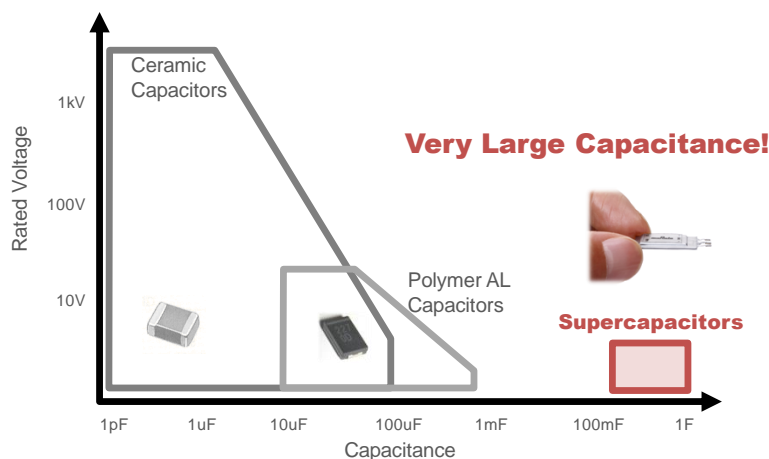

Fig. 9 High capacitance of Murata’s supercapacitors

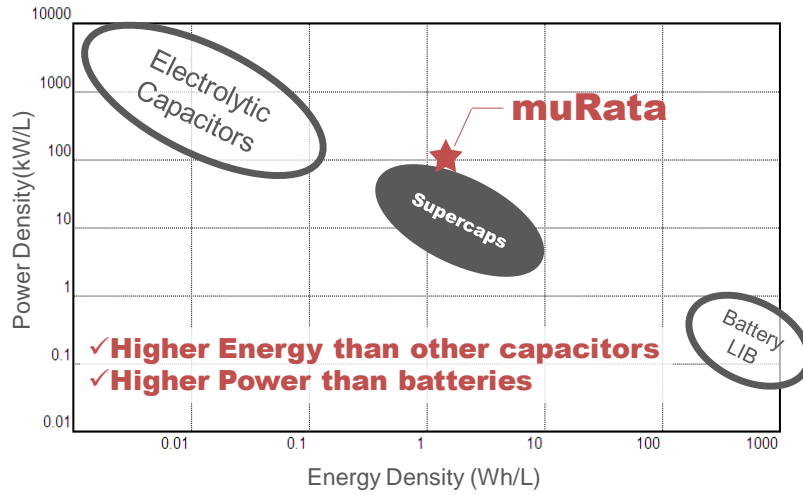

Fig. 10 Comparison of power density and energy density

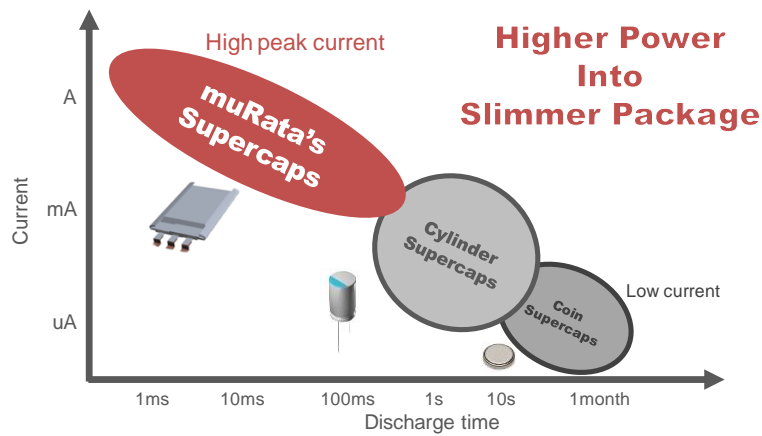

Fig. 11 Comparison with conventional supercapacitors

**Your Benefits**

- ✓ Versatile applications
- ✓ High power function
- ✓ Secure line voltage stability
- ✓ Reliable interim power supply
- ✓ Maintenance-free storage
- ✓ You can design slim devices with those benefits



In comparison with conventional supercaps...

- ✓ Higher Power
- ✓ Lower Profile
- ✓ Higher Reliability

**Key Features**

Fig. 12 Key Features of Murata's supercapacitors and your benefits

2.2. High energy

Murata’s supercapacitors have high energy in a slim package. For example, Murata’s 4.2 V 470 mF supercapacitor has approximately 4,000 mJ at initial state and 2,000 mJ even after 5 years passed under 50°C (\* 1). Such energy is equal to 70 times of a 6.3 V 1,500 uF (30 mJ) tantalum electrolytic capacitor or 10 times of a 16 V 1,500 uF (200 mJ) aluminum electrolytic capacitor (Fig. 13). You can get higher energy or reduce space in your product by using Murata’s supercapacitors.

\* 1 Energy in a capacitor can be calculated by using  $E = \frac{1}{2}CV^2$  (where E is stored energy [J], C is the capacitance [F], V is the rated voltage [V]). Supercapacitors degrade little by little. Therefore the performance keeps gradually decreasing during long-term use (details in the section 6.2). Prediction of a performance after degradation is discussed in the section 7.2.

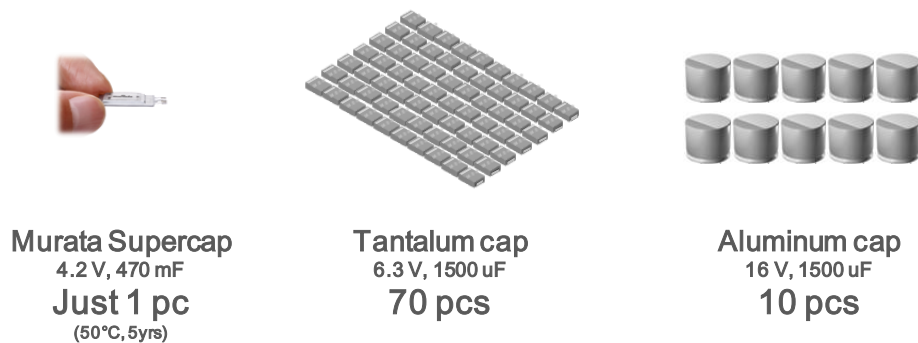

Fig. 13 Comparison in stored energy with tantalum capacitor and aluminum capacitor

2.3. High power

Murata’s supercapacitors have high power in a slim package. Lithium coin batteries (Li-MnO<sub>2</sub>), lithium thionyl chloride batteries (Li-SOCl<sub>2</sub>) etc are being used widely in long-life devices. However those batteries have only quite low power (Fig. 14). In this reason, devices with those batteries are limited to low power function. Even though alkaline batteries or small lithium ion batteries have higher power, it will have shorter life time under high-power load. Murata’s supercapacitors can assist those batteries for high-power function or long-time working with their quite higher power (Fig. 14).



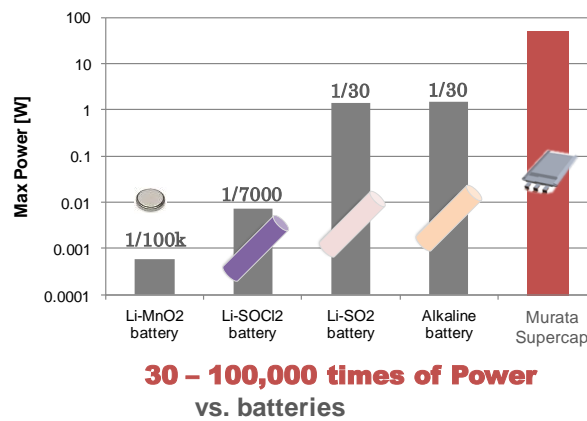

Fig. 14 Power comparison of Murata’s supercapacitor with various batteries

2.4. High reliability

In general, supercapacitors have an aging degradation issue which is caused by moisture from outside. Also, they have a dry-up failure issue. Murata’s supercapacitors were improved in durability to the aging degradation and the dry-up failure (see the section 6).

Moisture enters into package via sealant part. Murata’s supercapacitors are designed its sealant part to be small in order to inhibit moisture (Fig. 15). Therefore there is little damage by moisture compared with cylindrical supercapacitors which can be damaged heavily (Fig. 16). This smallest-designed sealant can also cut down on evaporation of electrolytic solution which causes dry-up failure (Details in the section 6.1).

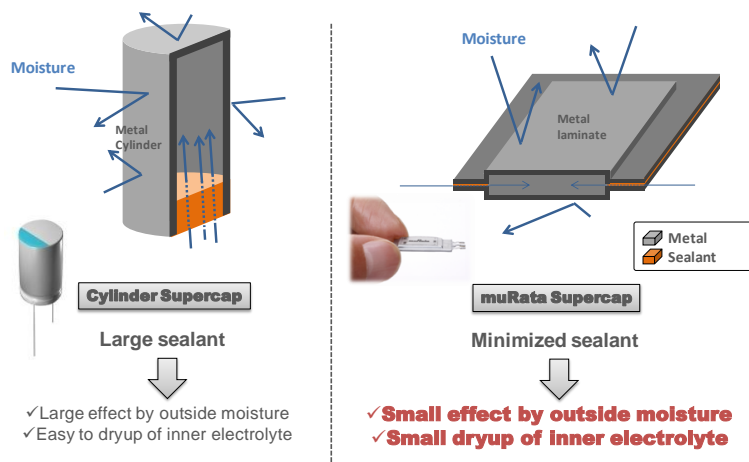
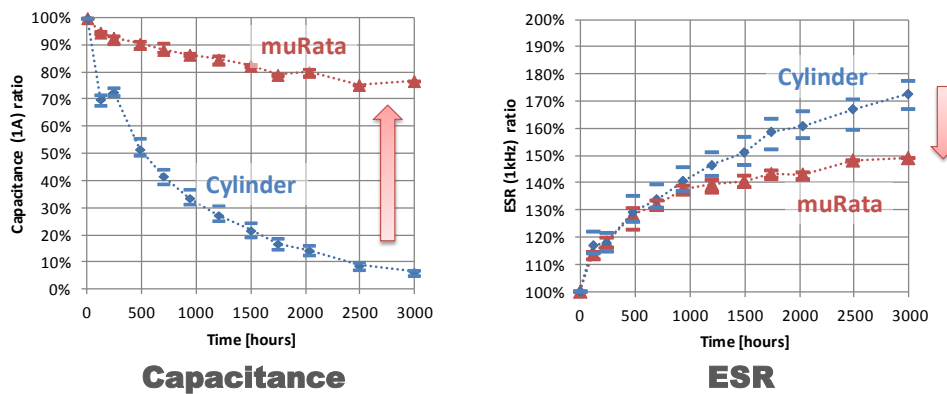

Fig. 15 Good package sealing of Murata’s supercapacitor for high reliability (against outside use and dry up of electrolytic solution)



- ✓Cylinder supercap has large degradation.
- ✓Murata’s supercap has **small degradation**.

Cylinder supercap: Company A, 5V 470mF  
 Murata supercap: Murata, 5.5V 350mF, DMF3R5R5L334M3D

Fig. 16 Excellent reliability of Murata’s supercapacitor than cylindrical one (40°C, 4.5V test)

### 3. Supercapacitor solutions in your devices

#### 3.1. High peak load leveling

When you have a problem about low battery power, Murata’s supercapacitors can support it. Connecting the supercapacitor to your battery in parallel can boost the power in your device (Fig. 17). This will enable you to improve product performance and quality. For example, it can improve RF transmission distance to be long, bass sound quality and so on.

If your battery voltage is over supercapacitor’s rated voltage (4.2 V~5.5 V), you can use multiple supercapacitors in series connection (This is discussed in the section 9.2).

Please see [application notes](#) in the Murata web site for more details.

#### High Peak Load Leveling

When electrical load is too high for battery and battery voltage becomes unstable, high-power supercap can assist it and decrease load to battery. You can improve quality of your product in RF, audio and so on.

- ✓ High-power RF(GPRS, etc...)
- ✓ High-quality Audio

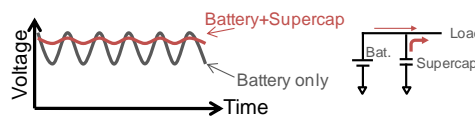

Fig. 17 Supercapacitor solution for high peak load leveling

#### 3.2. High peak power function

When you have a problem about quite high peak power in your product, Murata’s supercapacitors can support it. The supercapacitors can discharge up to ten amperes for such peak load. Supercapacitor is charged from power source in advance. When a high power load happens, supercapacitor discharge to the

load (Fig. 18). This will enable you to add new high power function to your product. For example, high brightness LED flash can be added to smart phone, high peak motor function can be added with low power battery.

If your battery voltage is over supercapacitor’s rated voltage (4.2 V~5.5 V), you can use multiple supercapacitors in series connection (This is discussed in the section 9.2).

Please see [application notes](#) in the Murata web site for more details.

**High Peak Power Function**

When you need quite high power which power source cannot provide, supercap can support it. You can add high-power function to your product.

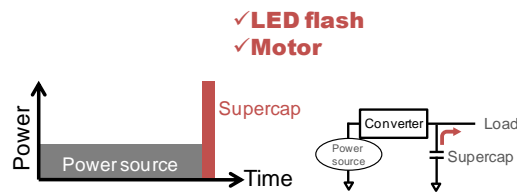

Fig. 18 Supercapacitor solution for high peak power function

3.3. High-power backup

When you have problems about lack of back-up energy or power in your system, Murata’s supercapacitors can support it. The supercapacitor is placed between a power source and a load in parallel. It is charged by the power source all the time. When power loss happens, the supercapacitor can discharge to the load (Fig. 19). This will enable you to gain high-power, long-time and long-life back-up in your product. For example, SSD (Solid State Drive) can have high-power and long-life back up for power loss protection into slim devices and portable devices can keep working during battery replacement.

If voltage of your power source is over supercapacitor’s rated voltage (4.2 V~5.5 V), you can use a few supercapacitor in series connection (This is discussed in the section 9.2).

Please see [application notes](#) in the Murata web site for more details.

**High-power Back up**

When you need backup energy in case of unexpected shut down of power source, supercap can support it. You can design large-energy and high-power backup into slim and small devices.

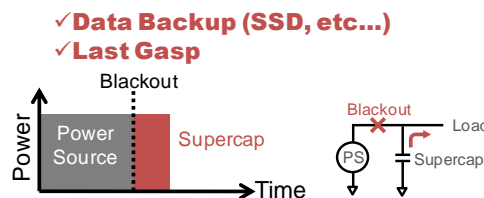

Fig. 19 Supercapacitor solution for high-power back up

3.4. Storage for energy harvest

Energy harvest systems usually have an unstable power generation from solar power, wind energy, thermal energy and so on. Murata’s supercapacitors can be charged and discharged easily. Therefore they are suitable for energy storage of the unstable power generation. The supercapacitor is placed between a harvester and a load. If the supercapacitor is charged enough, it can provide a stable power to the load (Fig. 20).

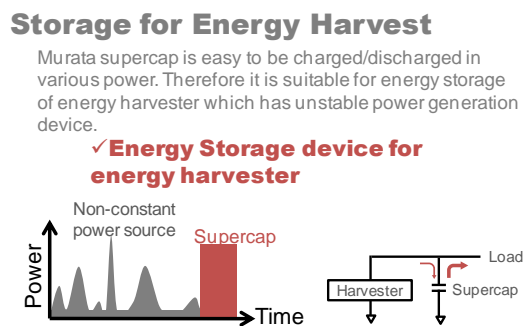

Fig. 20 Supercapacitor solution for storage of energy harvesting

**4. Lineup of Murata’s supercapacitors**

4.1. High-power versatile type; DMT series

DMT series is a high-power type of supercapacitors that is suitable for versatile applications (Table 1). It has very low ESR much less than one ohm and a wide temperature range from -40° to 85°C. Therefore it can be discharged at high current level up to 10 A and used to not only consumer applications but also industrial/enterprise applications such like FA application, smart meters and enterprise SSDs (solid state drives). Also, their thin thickness can realize mounting slim on surface of your circuit board (manual soldering).

In addition, DMT series has an excellent reliability in comparison with other supercapacitors in the market. It means much less degradation and a longer working time even under high temperature condition. Therefore you can easily use the supercapacitors without a much concern about it (see the section 6 for more details).

Please see the Murata web site for [the latest DMT line up](#).

Table 1 Line up of high-power supercapacitors; DMT series

P/N	Rated Voltage	Capacitance	ESR (1 kHz)	Dimensions	Operating Temperature
DMT3N4R2U224M3DTA0	4.2 V	220 mF ±20%	300 mΩ (320 mΩ Max)	21 x 14 x 2.2 mm (21.5 x 14.5 x 2.5 mm Max)	-40° to +85°C
DMT334R2S474M3DTA0	4.2 V	470 mF ±20%	130 mΩ (150 mΩ Max)	21 x 14 x 3.5 mm (21.5 x 14.5 x 3.8 mm Max)	-40° to +85°C

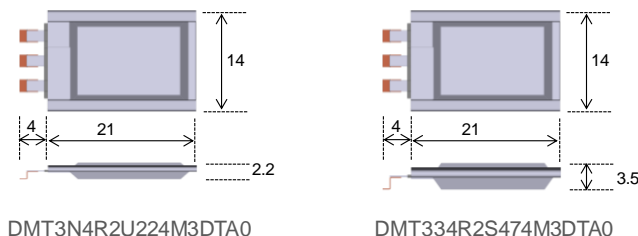

4.2. Ultra high-power type; DMF series

DMF series is an ultra high-power type of supercapacitors (Table 2). It has quite low ESR much less than 0.1 ohm and a temperature range from -40° to 70°C. It still has low ESR even under low temperature condition. Therefore it can be discharged at high 10 A levels in any temperature level. DMF series is suitable for high-brightness LED flash, high-power audio, smart meter (especially for cold area) and so on. Also, their thin thickness can realize mounting slim on surface of your circuit board (manual soldering).

In addition, DMF series has an excellent reliability in comparison with other supercapacitors in the market. It means much less degradation. Please note that DMF series has a limited working time (see the section 6 for more details).

Please see the Murata web site for [the latest DMF line up](#).

Table 2 Line up of ultra high-power supercapacitor; DMF series

P/N	Rated Voltage*	Capacitance	ESR (1 kHz)	Dimensions	Operating Temperature
DMF3Z5R5H474M3DTA0	5.5 V	470 mF ±20%	45 mΩ (55 mΩ Max)	21 x 14 x 3.2 mm (21.5 x 14.5 x 3.4 mm Max)	-40° to +70°C
DMF4B5R5G105M3DTA0	5.5 V	1,000 mF ±20%	40 mΩ (50 mΩ Max)	30 x 14 x 3.7 mm (30.5 x 14.5 x 4.0 mm Max)	-40° to +70°C

\*Rated voltage: 5.5V is the peak voltage. Maximum continuous operating time is limited by the applied voltage and temperature. For more details, please refer to the section “6.1 Dry up failure” and “6.4. Package bulging”

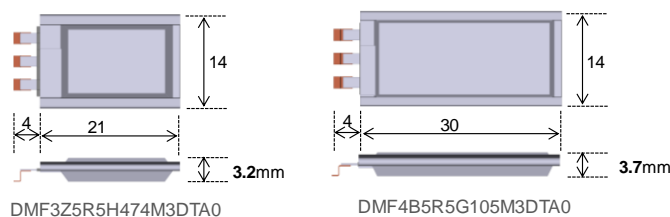

**5. Performance**

5.1. Capacitance

Murata’s supercapacitors have capacitance range from 220 mF to 1,000 mF as mentioned in the section 4. Those capacitances are defined by voltage drop speed during 100 mA constant-current discharge (Fig. 21). First, a supercapacitor is charged in 500 mA until it reaches the rated voltage and keeps at the voltage for 30 minutes. Then, it is discharged in 100 mA (I= 0.1 A).

Capacitance in every Murata’s supercapacitor is calculated by elapsed time from V<sub>1</sub> to V<sub>2</sub> by using below equation. Where, V<sub>1</sub> and V<sub>2</sub> are 80% and 40% of the rated voltage each other.

$$\text{Capacitance} = I \cdot \frac{T_2 - T_1}{V_1 - V_2}$$

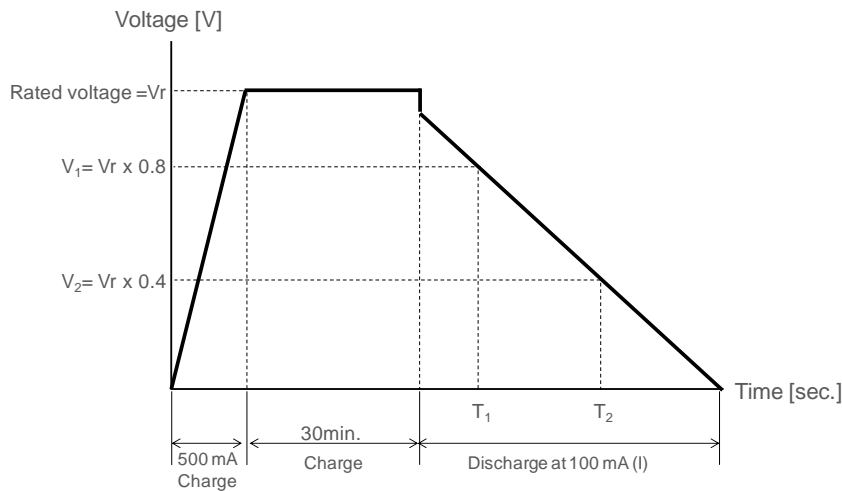

Fig. 21 Measurement of capacitance

5.2. ESR

Murata’s supercapacitors have ESR range from 40 mΩ to 300 mΩ as mentioned in the section 4. Those ESR are measured by AC 1 kHz method with using a resistance meter (Fig. 22). Measuring current is 10 mArms and no voltage bias is impressed.

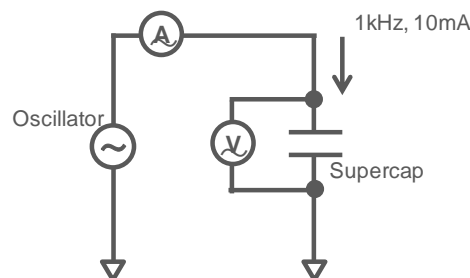

Fig. 22 Measurement of ESR

5.3. Constant current discharge

When a supercapacitor is discharged at a constant current condition, voltage on the supercapacitor drops almost linearly as time passes (Fig. 23).

An initial voltage drop is observed at the moment of discharging by its internal resistance (ESR) of the supercapacitor ( $\Delta V \approx I \cdot ESR$ ). Such initial voltage drop is observed larger at a higher current condition. Or it is also larger if ESR of a supercapacitor is higher.

After the initial drop, voltage of the supercapacitor drops with time. The drop speed depends on the current level and the nominal capacitance value ( $\frac{\Delta V}{\Delta t} \approx \frac{I}{C}$ ). The higher current is or the lower capacitance is, the more quickly voltage drops. However in case of quite high current discharge or quite low current discharge, the drop speed will be out of the relation  $\frac{\Delta V}{\Delta t} \approx \frac{I}{C}$  because supercapacitors have complex circuit of multiple parallel C (see the right picture in Fig. 8).

Fig. 24 and Fig. 25 show actual behaviors in Murata’s supercapacitors in cases of constant current discharge. 10 A current can be actually discharged from the supercapacitors.

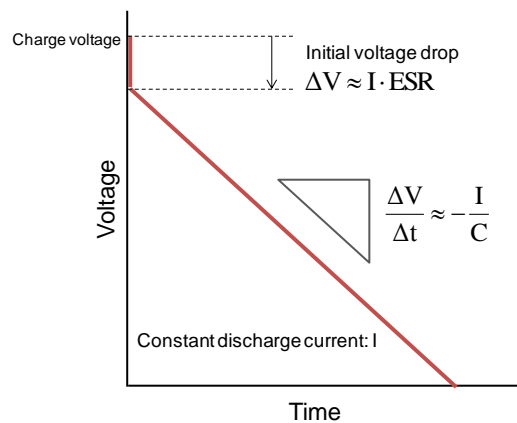

Fig. 23 Constant current discharge in a supercapacitor

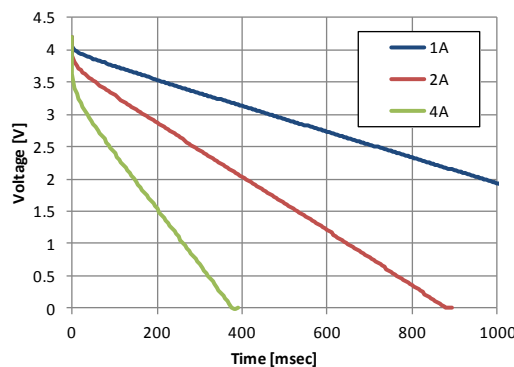

Fig. 24 Constant current discharge of DMT334R2S474M3DTA0 (discharge from 4.2 V @25°C)

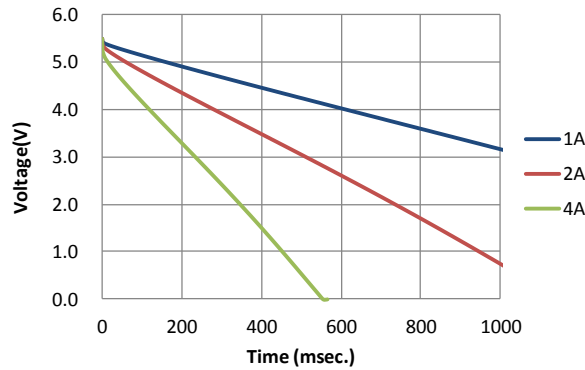

Fig. 25 Constant current discharge of DMF3Z5R5H474M3DTA0 (discharge from 5.5 V @25°C)

5.4. Constant power discharge

When a supercapacitor is discharged at a constant power condition, voltage on the supercapacitor drops as time passes (Fig. 26).

An initial voltage drop is observed at the moment of discharge by its internal resistance (ESR) in the supercapacitor ( $\Delta V \approx \frac{P \cdot ESR}{V_c}$ ). Such initial voltage drop is observed larger at a higher power condition. Or it is also larger if ESR of a supercapacitor is higher.

After the initial drop, voltage of the supercapacitor drops with time. The drop speed depends on the discharge power P, the nominal capacitance value C and the voltage level  $V_n$  at each moment.

$$\frac{dv}{dt} = \frac{P}{C \cdot V_n}$$

The higher power is or the lower capacitance is, the more quickly voltage drops. In addition, the drop speed will get higher in lower voltage level as time passes (Fig. 26). However in case of quite high-power discharge or quite low-power discharge, the drop speed will be out of the relation  $\frac{dv}{dt} = \frac{P}{C \cdot V_n}$  because supercapacitors have complex circuit of multiple parallel C (see right picture in Fig. 8).

Fig. 27 and Fig. 28 show actual behaviors of Murata’s supercapacitors in cases of constant power discharge. More than 30 W power can be discharged from the supercapacitors.



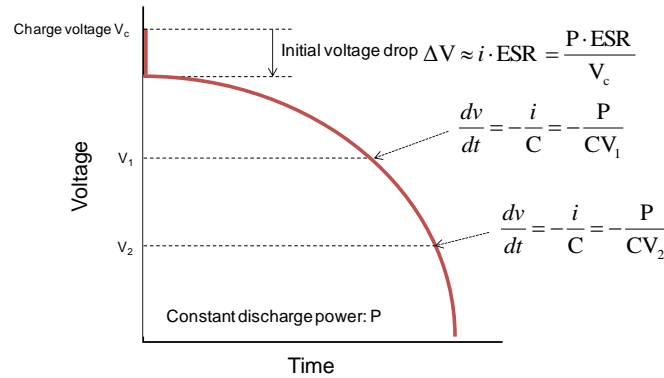

Fig. 26 Constant power discharge in a supercapacitor

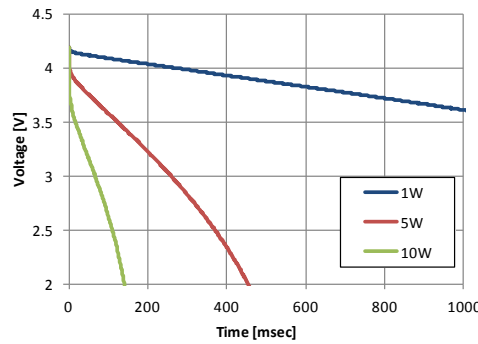

Fig. 27 Constant power discharge of DMT334R2S474M3DTA0 (discharge from 4.2 V @25°C)

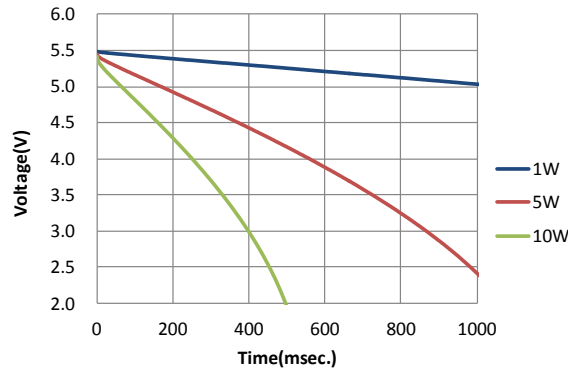

Fig. 28 Constant power discharge of DMF3Z5R5H474M3DTA0 (discharge from 5.5 V @25°C)

5.5. Temperature dependences (Cap, ESR, thickness)

Murata’s supercapacitors have temperature dependences in capacitance, ESR and thickness (Fig. 29, Fig. 30).

In case of DMT334R2S474M3DTA0, the capacitance gets lower at lower temperature. The capacitance at -40°C is 70% of the one at 25°C. This is because that DMT has higher inner resistances especially at lower temperature and ions at deeper site are not discharged easily (Fig. 8). It means that electric charges

cannot be discharged fully at a low temperature. The ESR gets lower at higher temperature and higher at lower temperature. The ESR at 85°C is half of the one at 25°C and the ESR at -40°C is 9 times of the one at 25°C. This dependence is caused by temperature dependence in viscous resistance of its electrolytic solution. The thickness does not change much even at both of low temperature and high temperature.

DMF3Z5R5H474M3DTA0 has almost no change in the capacitance at temperature range from -40°C to 70°C. The ESR gets higher at lower temperature. The ESR at -40°C is 2.5 times of the one at 25°C. This dependence is caused by temperature dependence in viscous resistance of its electrolytic solution. The thickness gets larger at a higher temperature and it gets slightly thicker approx. 0.25 mm at 70°C.

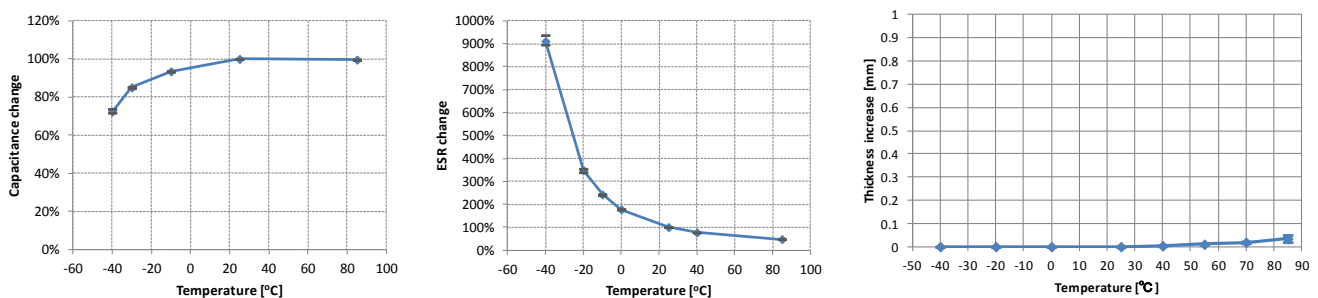

Fig. 29 Temperature dependence of DMT334R2S474M3DTA0

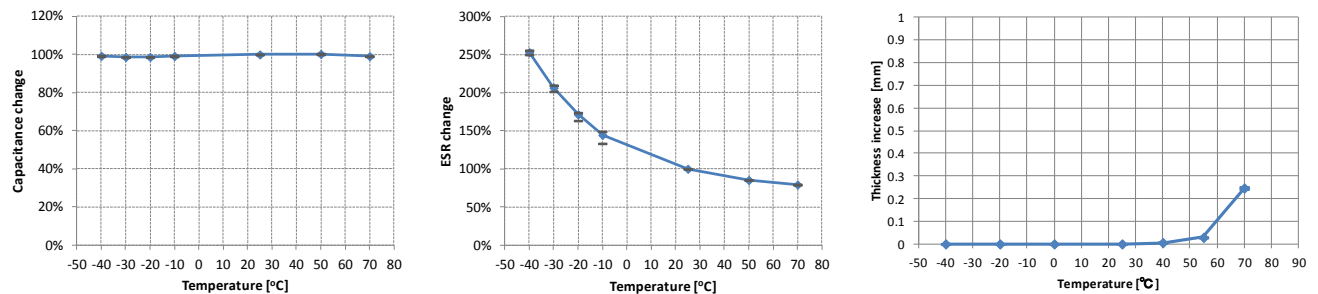

Fig. 30 Temperature dependence of DMF3Z5R5H474M3DTA0

**5.6. Current (Charge current and leakage current)**

Supercapacitors have characteristic behaviors in current during charging. Fig. 31 and Fig. 32 show charge current behaviors in an ideal capacitor and in a supercapacitor each other.

In the case of an ideal capacitor, the charge current will decrease rapidly with time and it will get fully-charged in a short time. After fully charged, leakage current will be observed (Fig. 31).

In the case of a supercapacitor, however, the electrodes actually have a complex structure with a lot of various-size pores in activated-carbon particles and a complex equivalent circuit model as mentioned in the section 1.3 (Fig. 8, Fig. 32). Such a complex structure which is described as a combination of multiple parallel C and series R is contributing to the characteristic charge-current. Shallow site of electrode generally has low C and low R. Therefore high current will flow for quite short time. In contrast, deep site

has high C and high R. Therefore trickle current will keep flowing for quite long time. From those reasons, supercapacitors take quite long time to be fully charged and low charge-current trickles over time.

For lots of application, there is no need to consider such trickle charge-current, however when a supercapacitor is used for applications that have low charge power such as energy harvester, it should be considered.

Fig. 33 and Fig. 34 show charge-current behavior of actual Murata's supercapacitors. Trickle current can be observed for hundreds hours. Real leakage current can be considered as less than 1  $\mu\text{A}$ .

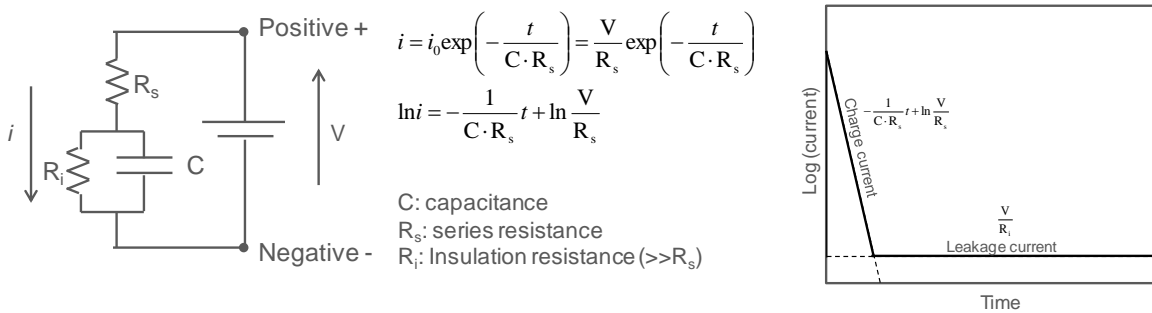

Fig. 31 Charge current in an ideal capacitor

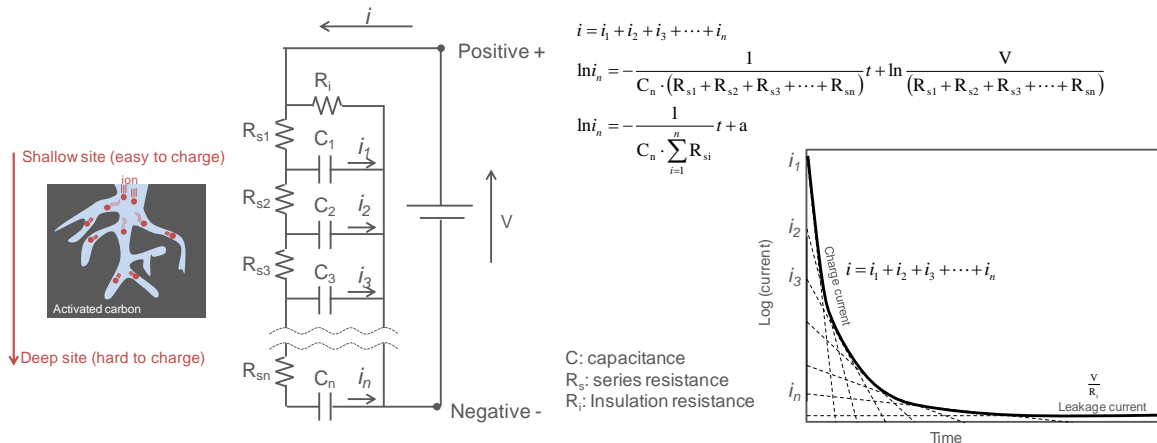

Fig. 32 Charge current in a supercapacitor

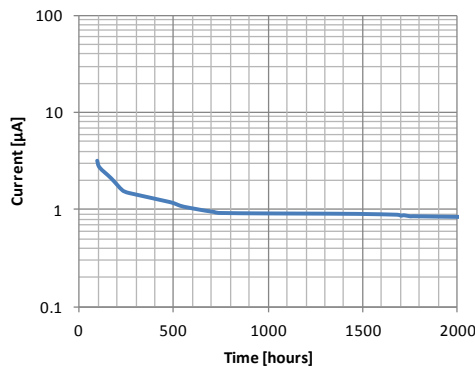

Fig. 33 Charge-current of DMT334R2S474M3DTA0 (4.2 V 25°C, n=10)

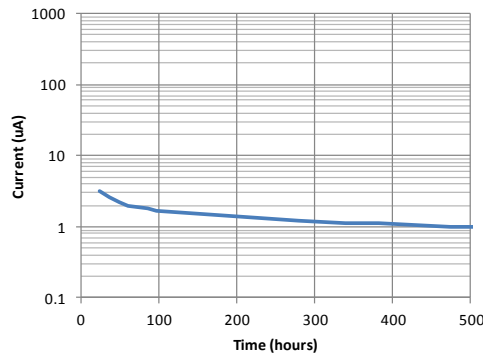

Fig. 34 Charge-current of DMF3Z5R5H474M3DTA0 (5.5 V 25°C, n=10)

## 6. Reliability

### 6.1. Dry up failure

Dry up failure is an open-circuit failure. It is caused by evaporation of inner electrolytic solution to outside. Such evaporation occurs little by little for long time. During enough volume in electrolytic solution for supercapacitor to work well, there is no effect to its electrical performances. Only when the volume gets a limited-minimum level for supercapacitor to work well, its capacitance gets lower rapidly and its ESR gets higher rapidly. Then supercapacitor cannot work in the end (Fig. 35).

Murata’s supercapacitors have an excellent durability to dry up. Because the package is designed to have good sealing to prevent dry up (Fig. 36).

Dry up life time depends on temperature condition in use because the evaporation speed depends on it. Please refer an indication on Fig. 37 for considering dry up life time.

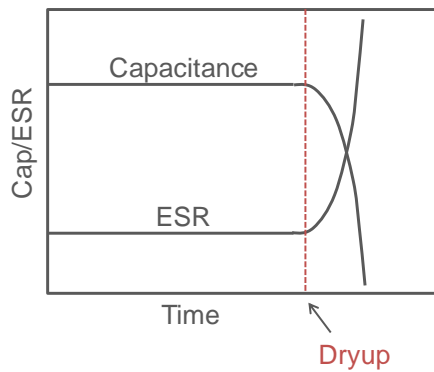

Fig. 35 Capacitance and ESR change by dry up

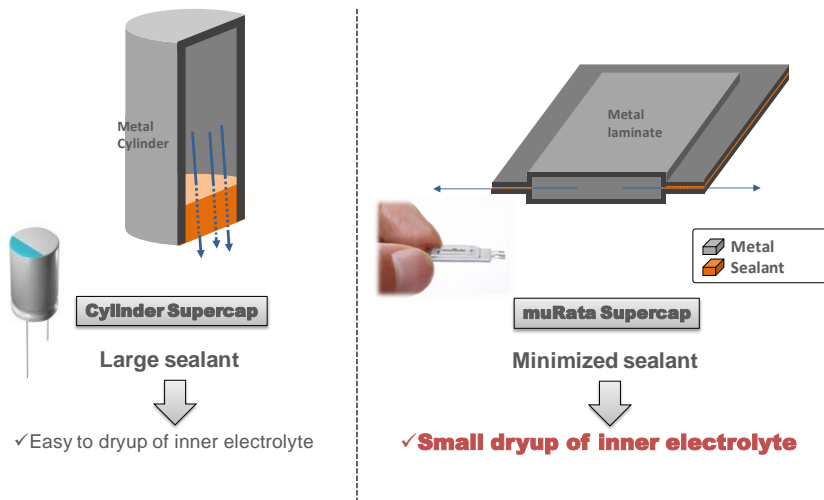

Fig. 36 Good package design for reducing dry up

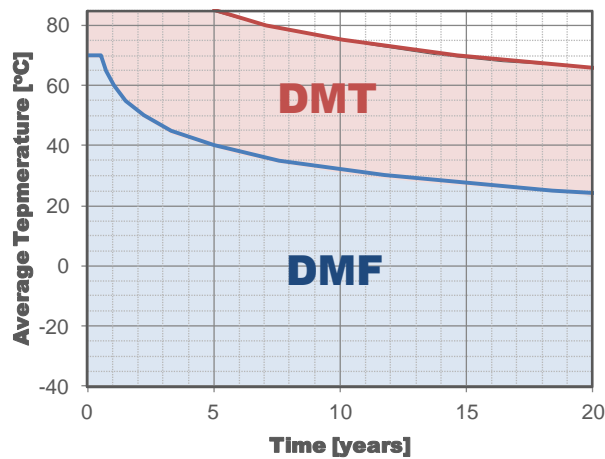

Fig. 37 Indication of dry up life time

6.2. Aging degradation

Aging degradation causes capacitance decrease and ESR increase over time (Fig. 38). The degradation is caused by an electrochemical reaction between inner moisture and electrolytic solution. Such reaction makes impurity on surfaces of electrodes that results in the capacitance/ESR degradation. The electrochemical reaction rate depends on temperature and voltage, and moisture entering depends on temperature. Therefore aging speed depends on temperature and voltage.

Murata’s supercapacitors have an excellent durability to aging degradation (Fig. 16). Because the package is designed to have good sealing to prevent moisture (Fig. 15).

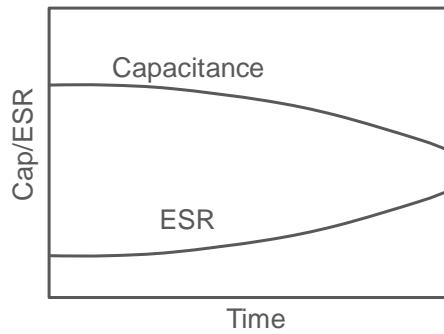

Fig. 38 Aging degradation in Capacitance and ESR

Fig. 39 and Fig. 40 show examples of 4.2 V 70°C test for 12,000hours to DMT334R2S474M3DTA0 and 4.2 V 40°C test for 9,000 hours to DMF3Z5R5H474M3DTA0. Aging degradation was observed in each test. Although such degradation is fast at first, it converges gradually.

Aging degradations in Murata’s supercapacitors are predictable by using Murata original simulation tools (see the section 7.2).

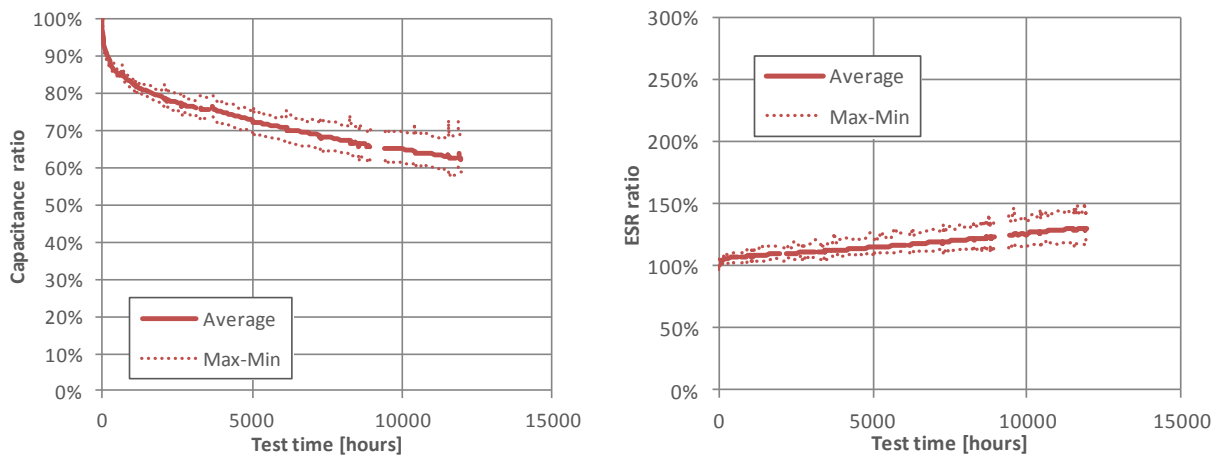

Fig. 39 Capacitance/ESR change at 4.2 V 70°C for DMT334R2S474M3DTA0

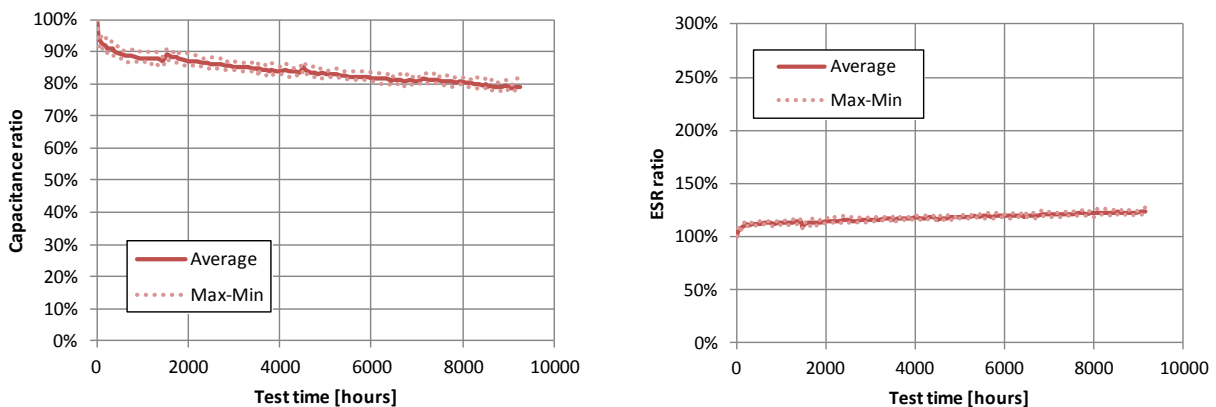

Fig. 40 Capacitance/ESR change at 4.2 V 40°C for DMF3Z5R5H474M3DTA0

6.3. Charge/discharge cycle life

Murata’s supercapacitors have excellent durability to charge/discharge cycle load. This is because of no electrochemical reaction that will cause large degradation during charge/discharge unlike batteries or lithium ion capacitors (hybrid capacitors).

Fig. 41 shows an example of charge/discharge cycle tests. DMT334R2S474M3DTA0 is charged to 4.2 V in 0.5 A current and kept at 4.2 V for 3.5 seconds. Then it is discharged to 0 V in 0.5 A current and kept at 0 V for 3.5 seconds. The charge/discharge cycle was repeated for 100,000 cycles. Even after the cycle load, almost no degradation in capacitance and ESR were observed like Fig. 41.

When you use our supercapacitors in continuous high-frequent charge/discharge for long time, please note its self heating (heat generation) resulting in larger aging degradation (see the section 12.3).

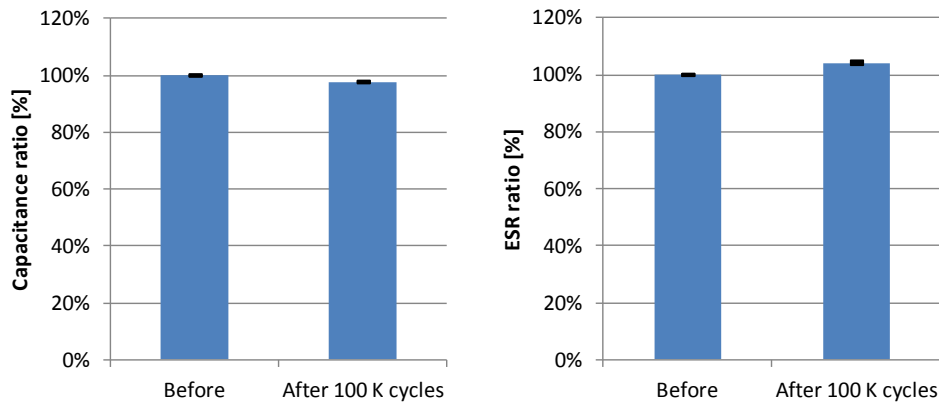

Fig. 41 Charge/discharge cycle test to DMT334R2S474M3DTA0  
(4.2 V~0 V cycle, 100,000 cycles, charge/discharge current 0.5 A)

6.4. Package bulging

Supercapacitors have package bulging during the use for long term. Such bulging is caused by electrochemical reaction (aging) between inner moisture and electrolytic solution.

Fig. 42 shows examples of DMT334R2S474M3DTA0 about relation between package bulging and operating time in various conditions. In the case of use at 40°C and 55°C, it will have almost no bulging for 5 years (44,000 hours). On the other hand, in the case over 70°C, there will be larger bulging at higher voltage.

Fig. 43 shows examples of DMF3Z5R5H474M3DTA0. For example, if it is used at continuous 3.0 V 40°C, it will have almost no bulging for 5 years (44,000 hours). On the other hand, when used at continuous 4.2 V 70°C, it will have 1 mm bulging just after 1,000 hours. Also, please note that there is a concern about package damaging if the bulging gets over 1.25 mm especially on DMF3Z5R5H474M3DTA0 (e.g. bulging at 5 V 60°C will get 1.25 mm 1,000 hours later).

Please consider such bulging when you use our supercapacitors in your product. For other products, please ask us.

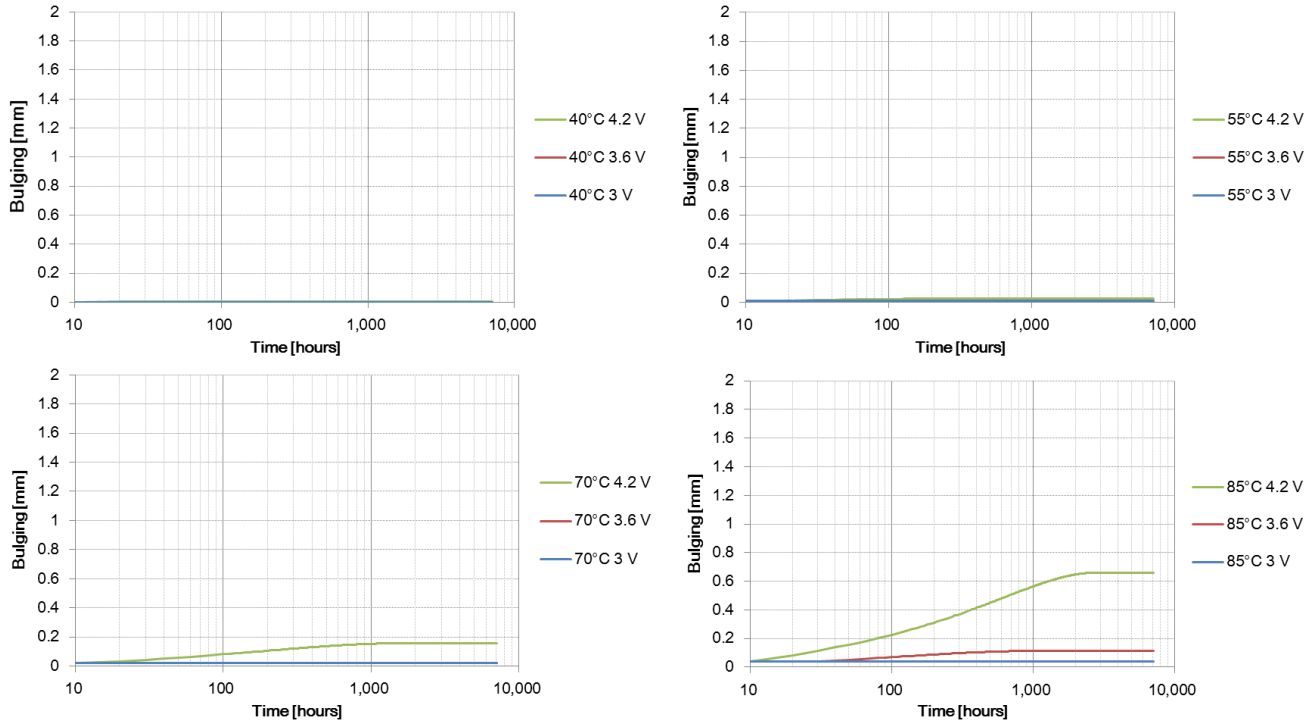

Fig. 42 Package bulging and operating time (DMT334R2S474M3DTA0)



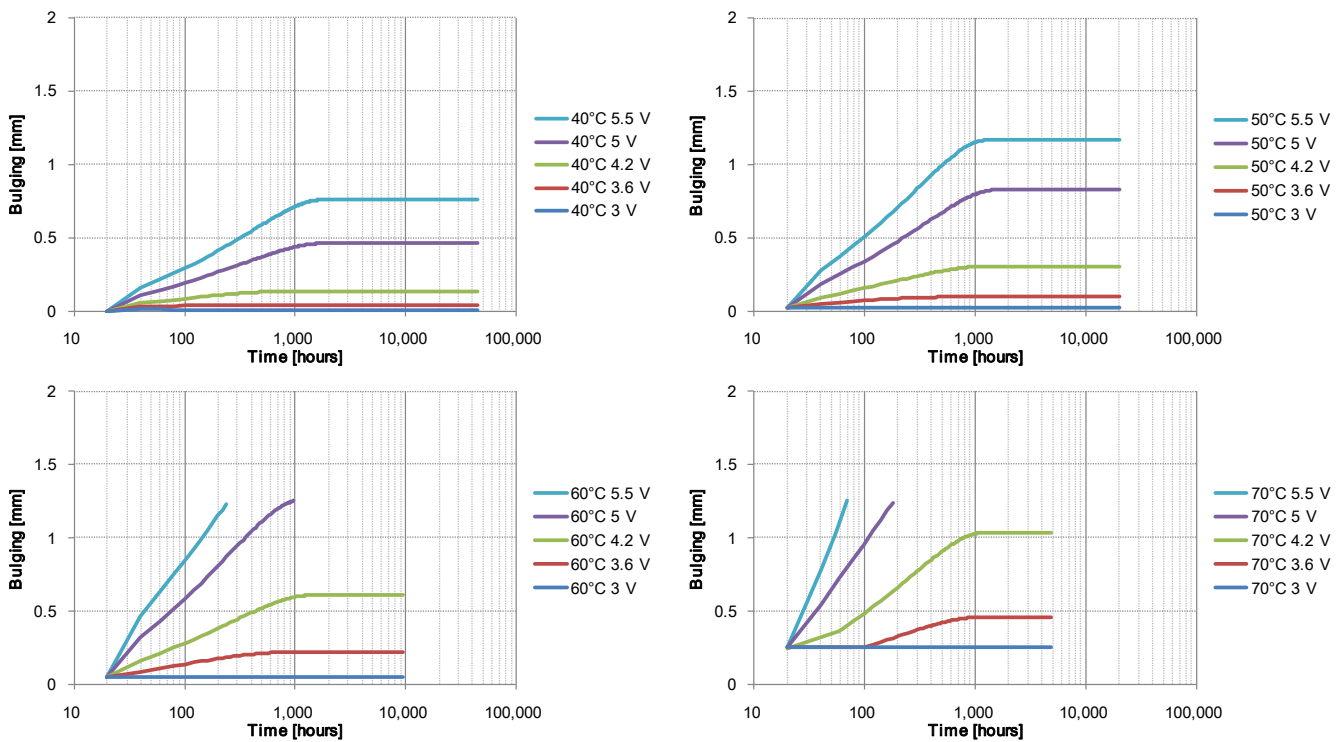

Fig. 43 Package bulging and operating time (DMF3Z5R5H474M3DTA0)

6.5. How to consider reliability

When you use Murata’s supercapacitors, aging degradation and dry up failure should be considered in many cases. There is only aging degradation until dry up starts (Fig. 44).

First step is to check if dry up life time is enough in your temperature condition by using the indication on Fig. 37. Second step is to check if supercapacitor performance is enough in your voltage/temperature condition by using Murata original simulation tools (see the section 7.2).

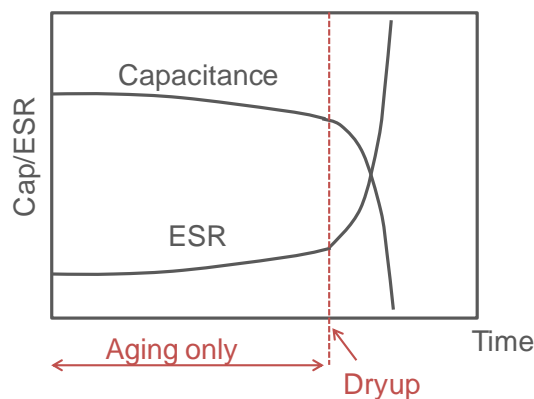

Fig. 44 Capacitance and ESR change in actual case

## 7. Technical supports

### 7.1. Application notes

Murata provides several particular application notes for supercapacitor. Please visit the Murata's web site for [supercapacitor's application notes](#).

### 7.2. Simulation tools for degradation and performance

When you use Murata's supercapacitors in your product, Murata's original simulation tool would help you design. It can estimate accurately how a supercapacitor will degrade and how a supercapacitor will be discharged in your condition (Fig. 45).

For example, if a supercapacitor is used at continuous 3.6 V 40°C for 5 years in your product, the simulation tool can respond its discharge performance with calculating the aging degradation after 5 years at 3.6 V 40°C (see the section 6.2) in the detailed equivalent circuit model (see the section 1.3). In addition, performance in using multiple supercapacitors in series or/and in parallel (see the section 9. Multiple connection) can be also estimated if you want.

The simulation tools are based on acceleration factors of voltage and temperature. Such acceleration factors were obtained from several actual acceleration tests.

The simulation tools are available at "Supercapacitor site" of "my Murata" on our website. "my Murata" is a website for members only provided by Murata Manufacturing Company, Ltd. Please register now and make use of it for your design. (URL : <https://my.murata.com/en/web/capacitor-edlc/home>)

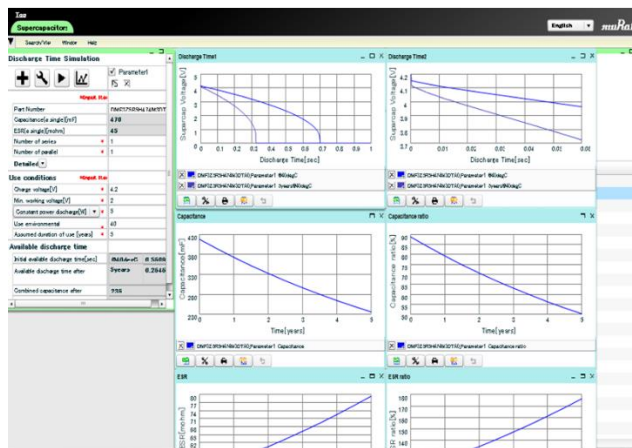

**Simulation tools, available in any conditions.**

**[Use-condition parameters]**

- ✓ Charge voltage
- ✓ Temperature
- ✓ Expected life time
- ✓ Discharge current or power
- ✓ Minimum working voltage you can accept
- ✓ Supercapacitor connection (series or/and parallel)

**[Simulation output]**

- ✓ Capacitance/ESR degradation
- ✓ Discharge behavior (voltage vs time) at end of set life

Fig. 45 Simulation tool for performance in any condition

7.3. Simulation examples

Several examples of estimated capacitance and ESR degradation in various conditions are shown in this section. They are the times at which capacitance reaches 50% of the initial value and ESR reaches 2 times of the initial values (Fig. 46).

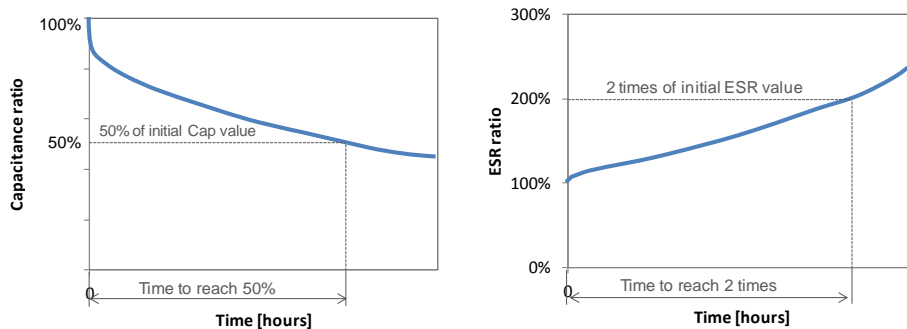

Fig. 46 Times at which capacitance reaches 50% and ESR reaches 2 times of the initial values

Estimated time at which capacitance reaches 50% of the initial value and ESR reaches 2 times of the initial value in DMT334R2S474M3DTA0 are shown in Table 3 and Table 4. The conditions are 3.0 V to 4.2 V at 40°C to 80°C.

Table 3 Times at which capacitance reaches 50% of the initial value in DMT334R2S474M3DTA0

	40 °C	50 °C	70 °C	80 °C
<b>3.0 V</b>	140,000 hours (16 years)	88,000 hours (10 years)	44,000 hours (5 years)	28,000 hours (3.2 years)
<b>3.6 V</b>	88,000 hours (10 years)	61,000 hours (7 years)	28,000 hours (3.2 years)	18,000 hours (2.1 years)
<b>4.2 V</b>	66,000 hours (7.5 years)	44,000 hours (5 years)	19,000 hours (2.2 years)	13,000 hours (1.5 years)

Table 4 Times at which ESR reaches 2 times of the initial value in DMT334R2S474M3DTA0

	40 °C	50 °C	70 °C	80 °C
<b>3.0 V</b>	>175,000 hours (>20 years)	>175,000 hours (20 years)	61,000 hours (7 years)	32,000 hours (3.7 years)
<b>3.6 V</b>	>175,000 hours (>20 years)	158,000 hours (18 years)	48,000 hours (5.5 years)	25,000 hours (2.9 years)
<b>4.2 V</b>	>175,000 hours (>20 years)	131,000 hours (15 years)	38,000 hours (4.3 years)	20,000 hours (2.3 years)

Estimated time at which capacitance reaches 50% of the initial value and ESR reaches 2 times of the initial value in DMF3Z5R5H474M3DTA0 are shown in Table 5 and Table 6. The conditions are 3.0 V to 5.5 V at 20°C to 40°C.

Table 5 Times at which capacitance reaches 50% of the initial value in DMF3Z5R5H474M3DTA0

	20 °C	30 °C	40 °C
<b>3.0 V</b>	175,000 hours (20 years)	88,000 hours (10 years)	44,000 hours (5 years)
<b>3.6 V</b>	175,000 hours (20 years)	88,000 hours (10 years)	44,000 hours (5 years)
<b>4.2 V</b>	158,000 hours (18 years)	79,000 hours (9 years)	44,000 hours (5 years)
<b>5.0 V</b>	66,000 hours (7.5 years)	35,000 hours (4 years)	19,000 hours (2.2 years)
<b>5.5 V</b>	44,000 hours (5 years)	22,000 hours (2.5 years)	12,000 hours (1.4 years)

Table 6 Times at which ESR reaches 2 times of the initial value in DMF3Z5R5H474M3DTA0

	20 °C	30 °C	40 °C
<b>3.0 V</b>	175,000 hours (20 years)	88,000 hours (10 years)	44,000 hours (5 years)
<b>3.6 V</b>	175,000 hours (20 years)	88,000 hours (10 years)	44,000 hours (5 years)
<b>4.2 V</b>	175,000 hours (20 years)	88,000 hours (10 years)	44,000 hours (5 years)
<b>5.0 V</b>	88,000 hours (10 years)	44,000 hours (5 years)	22,000 hours (2.5 years)
<b>5.5 V</b>	53,000 hours (6 years)	26,000 hours (3 years)	13,000 hours (1.5 years)

#### 7.4. Reliability report

When you need our support about reliability issues in using Murata's supercapacitor, we are supporting you with FIT date, MTTF data and reliability report including acceleration tests and acceleration model. The reliability reports are available at "Supercapacitor site" of "my Murata" on our website. "my Murata" is a website for members only provided by Murata Manufacturing Company, Ltd. Please register now and make use of it for your design.

(URL : <https://my.murata.com/en/web/capacitor-edlc/home>)

#### 7.5. Electrical circuit models and 3D schematics

The electrical circuit model (SPICE models) or 3D schematics are also available at "Supercapacitor site" of "my Murata" on our website. "my Murata" is a website for members only provided by Murata Manufacturing Company, Ltd. Please register now and make use of it for your design.

(URL : <https://my.murata.com/en/web/capacitor-edlc/home>)

### 8. Cautions for use

Cautions in using supercapacitor are mentioned in this section. However please be sure to check the cautions in the specification sheet of each product before using.

#### 8.1. Limitation to applications

Please contact us before using our products for the applications listed below which require especially high reliability for the prevention of defects which might directly cause damage to the third party's life, body or property.

(1) Aircraft equipment, (2) Aerospace equipment, (3) Undersea equipment, (4) Power plant control equipment, (5) Medical equipment, (6) Transportation equipment (vehicles, trains, ships, etc.), (7) Traffic signal equipment, (8) Disaster prevention / crime prevention equipment, (9) Data-processing equipment, (10) Application of similar complexity and/or reliability requirements to the applications listed in the above.

Please do not use this product for any applications related to military equipment.

## 8.2. Polarity

Please verify the orientation of supercapacitor and use in correct polarity in accordance with the marking on the product. In principle, supercapacitor has no polarity. However, if the inverse voltage is applied to supercapacitor, significant degradation of capacitance or leakage of electrolytic solution may be possibly caused.

## 8.3. Temperature and self heating

Please use supercapacitors within the specific operating temperature range with considering not only circumstance temperature but also self heating of supercapacitors. For reference, please see the section 12.3.

## 8.4. Soldering and assembling

Reflow and flow soldering cannot be accepted because body temperature of supercapacitor will get higher than allowable maximum temperature. Please use other mounting methods such as hand iron soldering, auto iron soldering, and so on.

Please do not apply excessive force to the capacitor during insertion as well as after soldering. The excessive force may result in damage to electrode terminals and/or degradation of electrical performance.

Recommendation of iron soldering is discussed in the section 11.

Please do not wash the device after soldering.

## 8.5. Fixation of supercapacitor

When mechanical stress can be applied on a supercapacitor due to drop or vibration, it can be fixed by resin coating or double-sided tape. If you have any questions or problems about fixing, please contact us.

If coating/molding a supercapacitor with resin, there is a risk that some resins may erode metal, or cure-stress of resin may distort terminal or package shape. Also there is a risk of heat generation. So please pay careful attention in selecting resin. Prior to use, please make the reliability evaluation with a supercapacitor mounted in your application set.

When fixing a supercapacitor on substrate with using double-sided tape, please do not overstress its package. Strong press may distort terminal or package shape. Removing a fixed supercapacitor from the substrate may detach device and tape, or distort terminal or package shape. Please do not use sharp tools when removing device from substrate.

8.6. Response to IATA Dangerous Goods Regulations

Every Murata’s supercapacitor in the section 4 has capacity less than 0.3 Wh. Therefore, they are not covered by 54th Edition of IATA Dangerous Goods Regulations effective from January 1, 2013.

**9. Multiple connection of supercapacitors**

9.1. Parallel connection

When higher energy and/or higher power are required in your system, you can get it by connecting some supercapacitors in parallel (Fig. 47). If N pieces of supercapacitors are connected in parallel, total capacitance becomes high to N times and total ESR becomes low to  $\frac{1}{N}$ . You can get both of higher energy (calculated from  $E = \frac{1}{2}CV^2$ ) and higher power. In case of parallel connection, it is possible to connect different parts of supercapacitors.

Please design balance circuit in any connection (described in the section 10).

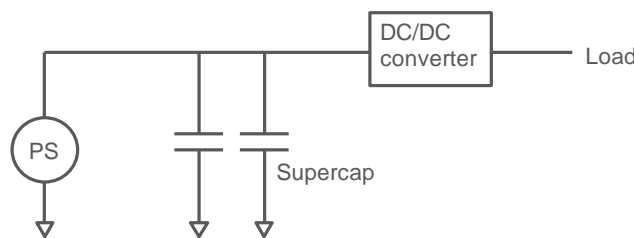

Fig. 47 Parallel connection of supercapacitors

9.2. Series connection

When power-supply voltage is over a rated voltage of a supercapacitor, some of the supercapacitors can be connected in series (Fig. 48). For example, when the power-supply voltage is 5 V in your product, a supercapacitor which has 4.2 V rated voltage cannot be used due to overvoltage. However if two supercapacitors are connected in series, they can accept up to 8.4 V therefore they can be used with 5 V power-supply.

In case of N pieces connection in series, the acceptable voltage would be N times of the rated voltage. Of course, total capacitance becomes low to  $\frac{1}{N}$  and total ESR becomes high to N times. However you would get higher energy (calculated from  $E = \frac{1}{2}CV^2$ ).

Additionally series connection has also an effect to reduce degradation of supercapacitor through long term. Such degradation depends on voltage. Therefore it is possible to reduce it by derating the impressed voltage per one supercapacitor.

When you use series connection, please do not pair any different part (different capacitance, different series, new/old, and so on). Please pair supercapacitors of completely same part number.

Please design balance circuit in any connection (described in the section 10).

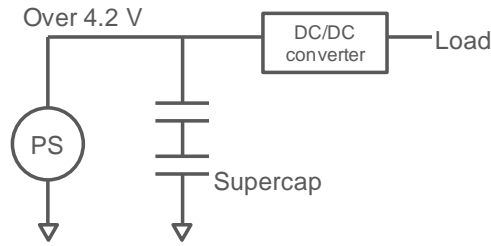

Fig. 48 Series connection of supercapacitors

**10. Voltage balance circuit**

Murata’s supercapacitors consist of two of unit capacitor cell in series for increasing voltage (Fig. 49). For example, DMF3Z5R5H474M3DTA0 (470 mF) consists of two of 940 mF cell in series ( $C_1=C_2=940$  mF). However there are actually variations in capacitance and insulated resistance between the two cells. Therefore there is a possibility that voltages impressed to each capacitor may be unbalanced due to the actual variations. Such voltage unbalance may result in overvoltage to one cell. The overvoltage will cause unexpected large degradation or short lifetime in supercapacitor.

For the reasons, voltage balance control is important in using supercapacitors. We recommend two methods, one is passive balance control and the other is active balance control.

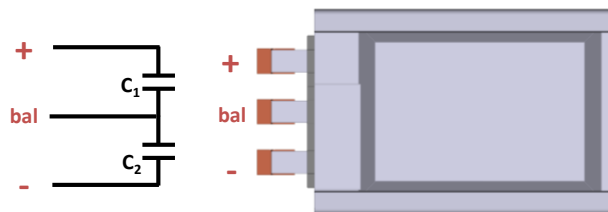

Fig. 49 Murata’s supercapacitors have two capacitors in series into one package

**10.1. Passive balance control**

Passive balance circuit consists of two resistors (Fig. 50). This is the simplest and lowest-cost solution. We recommend lower resistance value because it can contribute faster balancing voltages. Low resistance will result in power loss in your circuit however the loss is vanishingly low in many cases. For example it is just 8.8 mW even if 1 kΩ resistors are used (Table 7).



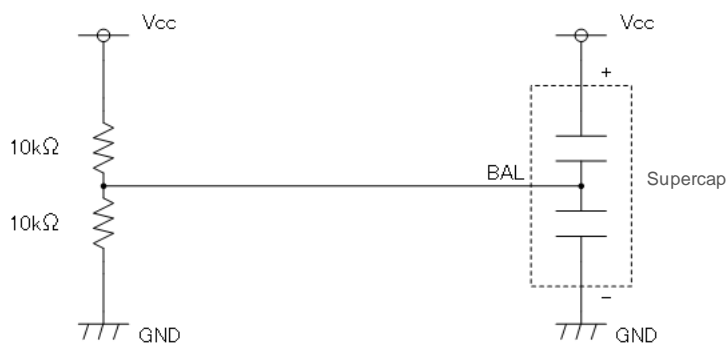

Fig. 50 Passive balance circuit

Table 7 Balance resistance value and balance current/power consumption

Resistance value	Maximum balance current	Voltage balancing speed	Power consumption through resistances	Circuit loss
1 kΩ	4.2 mA	Faster	8.82 mW	Higher
10 kΩ	420 uA	↑	882 uW	↑
100 kΩ	42 uA		88.2 uW	
1 MΩ	4.2 uA	↓	8.82 uW	↓
10 MΩ	420 nA	Lower	882 nW	Lower

(note) Values in chart are in case of 4.2 V impressed to supercapacitor products.  
 (Reference) Insulated resistance of supercapacitor is over 1 Mohm.

When you have a concern even to mW-level power loss, you can choose higher resistance. However there are limited maximum resistance values to keep good voltage balance shown in Table 8. If a supercapacitor is used at higher voltage, the voltage balance should be more severely controlled. Therefore the higher impressed voltage is, the lower maximum resistance value is. Please do not exceed the values shown in Table 8. Please contact us for supercapacitor products that are not listed in the table.

Table 8 Maximum resistance value

Impressed Voltage between + and -	Max. Balance Resistance value	
	P/N	DMT334R2S474M3DTA0
~2.7V	4.7 MΩ	No Need Balance
~3.0V	4.7 MΩ	4.7 MΩ
~3.2V	2.2 MΩ	2.2 MΩ
~3.6V	1.0 MΩ	1.0 MΩ
~4.0V	220 kΩ	470 kΩ
~4.2V	4.7 kΩ	220 kΩ
~4.5V		47 kΩ
~5.0V		4.7 kΩ
Over 5.0V		1.0 kΩ

10.2. Active balance control

Active balance control is a circuit using an operational amplifier (Fig. 51). This solution can contribute faster voltage balance by current amplification function even if high resistances are used.

Rated voltage of operational amplifier should be higher than  $V_{cc}$ . A damping resistor may be needed in order to avoid abnormal oscillation. Operational amplifier should be chosen with considering power consumption and drive current (Table 9).

Active balance circuit works only in case of voltage unbalance. After voltage balance converged, there is only power consumption of unloaded condition. Therefore active balance is excellent in energy efficiency. Operational amplifier with high slew rate has high speed motion and an advantage for short-time balance convergence. However such high-speed amplifier has high power consumption (Table 9). It should be chosen with considering your purpose.

There are dedicated ICs for voltage balance of supercapacitor. Table 10 shows the examples. Some ICs include charge/discharge voltage control function. Using these ICs is the best solution for voltage balance. In case of charge pump system IC, necessary external parts are only ceramic capacitors. However charge current is lower. In case of buck system IC or buck-boost system IC, charge current is high. However FET, power inductor and so on are needed.

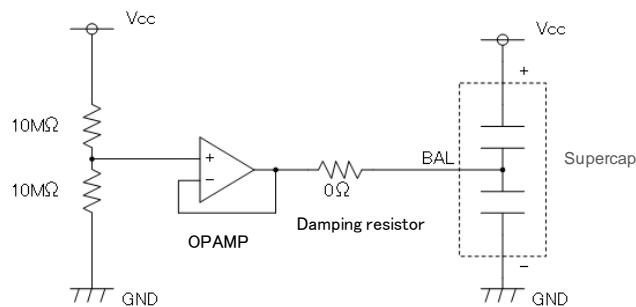

Fig. 51 Active balance circuit

Table 9 Operational amplifier properties

Indication for choice	General Properties	
Slew rate	Low ↔ High	
Drive current	Low ↔ High	
Power consumption	Low ↔ High	
Bandwidth	Narrow ↔ Wide	
Application	Wide use ↔ Particular use	
Cost	Low ↔ High	

Table 10 Examples of dedicated ICs (in alphabetical order)

Function	IC part number	Manufacturer	Max. charge current	Input voltage	Output voltage	Others
Balance control	ALD9100xx	Advanced Linear Technology	No limitation by IC	~15V	1.8V~2.8V / one cell	• For 2 series connection
	ALD8100xx					• Selectable gate threshold voltage
	BD14000EFV-C	Rohm	No limitation by IC	8V~24V	2.4V~3.1V / one cell	• For 4 -6 series connection
	bq33100	Texas Instrument	No limitation by IC	3.8V~25V	~5V / one cell	• For 2 -5 series connection
Backup Charge current control	OZ581	O2 Micro	3A	4V~36V	5V~20V	• Linear control charge
	SLG46533 -SLG46538	Silego Technology	2.5A (using SLG59M1563V load switch)	1.9V~5.0V	Same as input voltage	• Configurable mixed-signal IC (Selectable functions) • For details, please contact the IC manufacturer.
Balance control Overvoltage protection	SLG46116	Silego Technology	No limitation by IC	1.7V~5.5V	Same as input voltage	• Configurable mixed-signal IC (Selectable functions) • For details, please contact the IC manufacturer.
Balance control Backup Voltage regulation	AS3630	AMS	1A	2.5V~4.8V	4.5V~6V on two cells	• For LED flash • Charged with boosted input voltage
	LTC3128	Linear Technology	3A	1.73V~5.5V	1.8V~5.5V on two cells	• Charged with boosted or bucked input voltage
	LTC3225-1	Linear Technology	150mA	2.8V-5.5V	4.0V or 4.5V on two cells	• Charged with boosted input voltage
	LTC3350	Linear Technology	No limitation by IC	4.5V~35V	~5V / one cell	• For 1~4 series connection • Charged with bucked input voltage
	LTC3625-1	Linear Technology	1A	2.7V~5.5V	4.0V or 4.5V on two cells	• Charged with boosted input voltage
	TPS61325	Texas Instruments	220mA	2.5V~5.5V	3.825V~5.7V on two cells	• For LED flash • Charged with boosted input voltage

### 10.3. Comparison between passive balance and active balance

Table 11 shows comparison between passive balance and active balance. Passive balance method has advantages of small mount area and low cost. On the other hand, active balance method has advantages of high-speed balance convergence. Please choose balance method with considering function and cost.

Table 11 Comparison of passive and active balance

Type	Passive balance (Resistances)	Active balance (OPAMP)	Active balance (Dedicated IC)
Mount area	Small	Middle to Large	Large
Circuit cost	Low	Middle	High
Power consumption	Low (1MΩ) ~High (1kΩ)	Middle	Middle
Convergence speed	Slow	Fast	Fast
Operating voltage	No limit	Limited	Limited
Multiple series connection of supercaps	Possible	Possible	Limited
Operation during power-off	Possible	Impossible	Impossible
Control of charge voltage	Impossible	Impossible	Possible

(Note) Murata Manufacturing Co., Ltd. assumes no responsibility for any loss resulting from using IC's information in this section. Murata Manufacturing Co., Ltd. makes no representation that the interconnection of its circuits as described in this section will not infringe on existing patent rights.

## 11. Solder mounting method

Reflow or flow soldering cannot be used for Murata's supercapacitor DMT/DMF series because a capacitor body temperature will rise beyond maximum allowable temperature. Please use other mounting methods. These may include hand soldering, and so on. The recommended soldering conditions and cautions are as follows:

### 1. Pretreatment process

(1) Apply preliminary solder to the lands of a PCB

Applying method :

- Wire solder + Soldering iron
- Solder paste + Reflow

(2) It is recommended to temporarily fix a supercapacitor(EDLC) on the PCB by a double-stick tape.

### 2. Recommended hand soldering conditions

Solder Type: Resin flux cored solder wire (φ1.2mm)

Solder: Lead-free solder: Sn-3Ag-0.5Cu

Soldering iron temperature at 350 °C±10 °C

Solder Iron wattage: 70W max.

### 3. Recommended hand soldering method

(1) Please heat both the supercapacitor terminal and the PCB land by soldering iron and melt a solder on the land

(2) Please put pre-cut solder wire (for Φ 1mm, 2-3mm length) on a terminal and heat it according to the following conditions(\*\*).

(2)' Please put wire solder on a terminal and heat it according to the following conditions (\*\*).

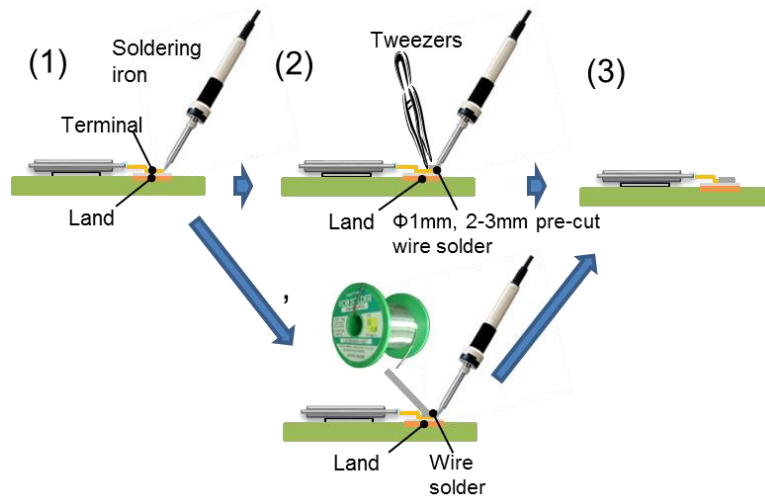

Fig. 52 Process of hand soldering

(\*\*)Soldering conditions

Soldering time : within 4 seconds per one terminal

Allowable soldering frequencies: 3 times maximum per one terminal.

Allowable cumulative soldering time per capacitor: 15 sec max total.

4. Recommended land pattern

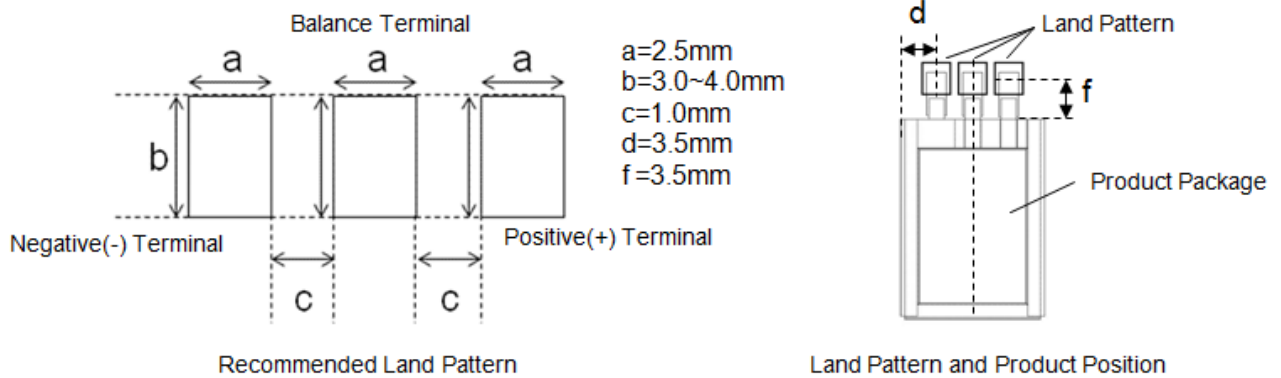

5. Cautions

- Please do not touch laminate package directly by solder iron.
- Please do not apply excessive force to the capacitor during insertion as well as after soldering.  
The excessive force may result in damage to electrode terminals and/or degradation of electrical performance.
- Please do not wash the device after soldering.

## 12. Safety

### 12.1. UL certification (UL 810A)

Every Murata’s supercapacitors in the section 4 received the safety standard UL 810A certification.

### 12.2. Short circuit by any possibility

Even if a fully-charged Murata’s supercapacitor is externally short-circuited by any possibility, there is no leakage of electrolytic solution, no smoke, no ignition or no rupture. The reason is because the supercapacitor has no high energy inside unlike batteries. DMT or DMF supercapacitors have just only 5 to 10 joules of energy. Since their ESR are from several tens to several hundreds of milli-ohm respectively, there is little heat generation even in case of short.

For information, when DMF3Z5R5H474M3DTA0 charged to 5.5 V is short-circuited, 120 A current will be flowed for a very short time (Fig. 53). Maximum current depends on internal resistance.

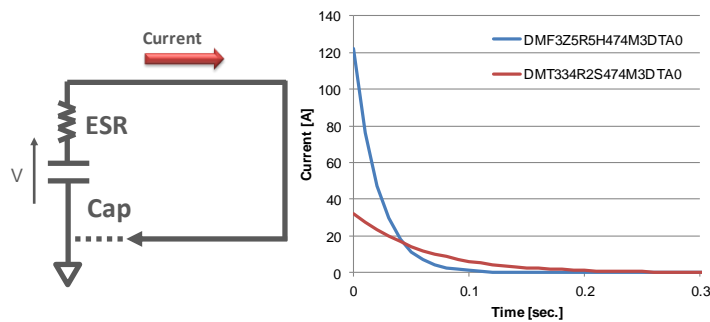

Fig. 53 Current simulation in case of external short circuit

### 12.3. Self heating

When you use supercapacitors, please note heat generation during charge/discharge. Such heat generation may be very small and it causes no problem in many cases because of very low energy in supercapacitors. However in case of high frequency use with high power, heat generation could be high as explained below.

Heating depends on consumption energy during charge or discharge of a supercapacitor. Usually supercapacitors have very lower energy than batteries. For example, while 4V 3,000 mAh battery has approximately 40 kJ energy, DMF3Z5R5H474M3DTA0 (5.5V 470mF) or DMT334R2S474M3DTA0 (4.2V 470mF) has only approximately 4 J to 7 J energy ( $E = \frac{1}{2}CV^2$ ). Therefore heat generation during charge or discharge is very small. At a rough estimate, those Murata’s supercapacitors have approximately 1 J/K heat capacity, therefore even if all the energy is instantly discharged (even in short circuit case), temperature will possibly increase less than 10°C. Also, such temperature increase is very momentary and it will decrease soon by heat radiation.

However, if charge/discharge cycle is repeated frequently, generated heat may be possibly accumulated

into a supercapacitor and high temperature may keep continuously. It depends on current, frequency and duty ratio. In other words, it is related with balance between heat generation and heat radiation (Fig. 54).

Fig. 55 is an example of actual heat generation of a supercapacitor. When 5 A peak current for 30 milliseconds is repeated every one second to DMF4B5R5G105M3DTA0 (5.5V 1,000mF), temperature increases gradually and converges at 3°C increase after 300 seconds. This converging status means that heating generation is equal to heat radiation.

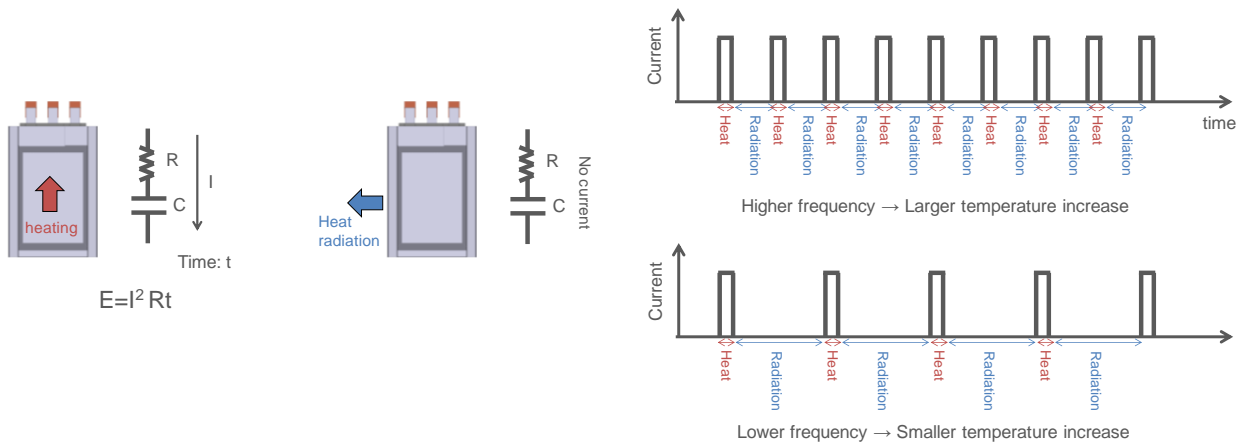

**Fig. 54 Heat generation and heat radiation**

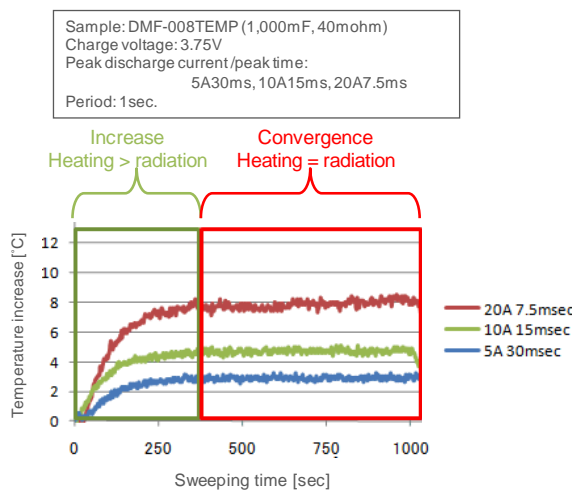

**Fig. 55 Example of actual heat generation**

**13. FAQs**

Please visit [Murata’s web site for FAQs about supercapacitors.](#)