

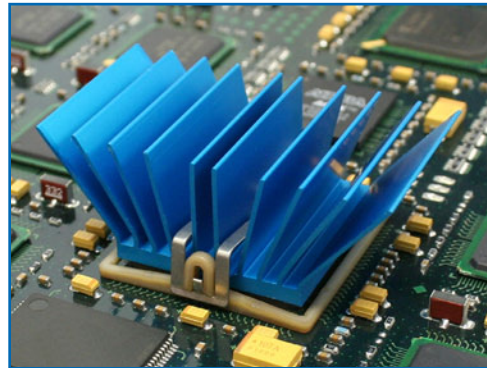

superGRIP™

HEAT SINK ATTACHMENT FOR DENSELY POPULATED PCBs

- Provides tight, secure heat sink attachment in shock and vibration environments
- Occupies minimal area around chip, allowing its use in densely populated PCBs
- Allows the heat sink to be detached and reattached without damaging the component or the PCB
- Strong, uniform attachment force helps achieve maximum performance from phase-changing TIMs



ATS' patented superGRIP™ Heat Sink Attachment System

About superGRIP™

ATS' superGRIP™ is a new two-component, attachment system which quickly and securely mounts heat sinks to a wide range of hot running Ball Grid Array (BGA) components, while using a minimal amount of space on the PCB and eliminating the need to drill holes.

The two-part superGRIP™ system features a plastic frame clip that fastens securely around the perimeter of a component and a metal spring clip which slips through the heat sink's fin field and locks securely to both ends to the plastic frame. The resulting superGRIP™ assembly applies steady, even pressure to the component throughout the product lifecycle, improving thermal performance and long-term reliability.

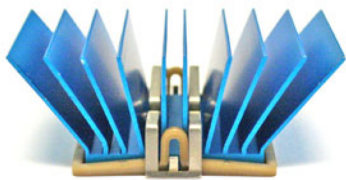

With this latest edition, ATS now offers two tiers of heat sink clip attachment: maxiGRIP™, for general purpose and high performance applications: and superGRIP™, for high performance applications with densely populated PCBs and little space around the component for mechanical attachment.

ATS' superGRIP™ heat sink attachment system permits the use of high performance phase changing thermal interface materials that improve heat transfer by as much as 20 times more than typical double-sided adhesive thermal tapes. It also allows for the heat sink to be detached and reattached without damaging the component or the PCB, an important feature for applications where PCB rework and ease of assembly and disassembly are important.

The superGRIP™ system is available with ATS' maxiFLOW™ family of heat sinks which feature a low profile, spread fin architecture to maximize surface area for more effective convection (air) cooling. Testing at an air flow rate of just 0.5 m/s (100 ft/m) shows that device junction temperatures (Tj) can be reduced by more than 20 percent below the temperatures achieved using heat sinks with traditional fin styles.

It is also available with ATS' straight fin and cross cut heat sinks, as well as additional sizes and configurations, as custom options.

For further technical information, please contact Advanced Thermal Solutions, Inc. at 1-781-769-2800 or www.qats.com

superGRIP™ FEATURES:

- » **Minimal Keep Out Area**
Requires minimal space around the component's perimeter; ideal for densely populated PCBs
- » **Improves Performance**
superGRIP's strong, uniform attachment force helps achieve maximum performance from phase changing thermal interface materials
- » **Easy Installation and Removal**
Allows heat sink to detached and reattached without damaging the PCB.
- » **Thermal Interface Material**
Comes standard with clean-break, reworkable, Chomerics T-766 phase change material
- » **Frame Clip**
Made from plastic resins that allow it to be thin, yet incredibly strong
- » **Spring Clip**
Flat, twin-channel clip, made from 300 series stainless steel, provides strong retention forces
- » **No Special Tools Needed**
Frame and spring clips can both be installed by hand or with common hand tools such as a flat blade screwdriver
- » **maxiFLOW™ Heat Sink**
Available with maxiFLOW™ heat sinks which maximize surface area for more effective convection (air) cooling
- » **Custom Options**
Clips and heat sink can be customized in different sizes



superGRIP™

HEAT SINK ATTACHMENT FOR DENSELY POPULATED PCBs

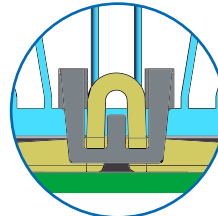
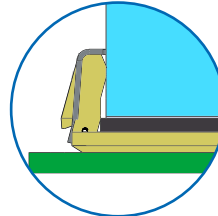
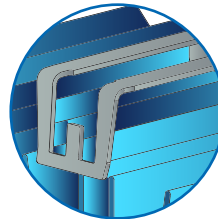
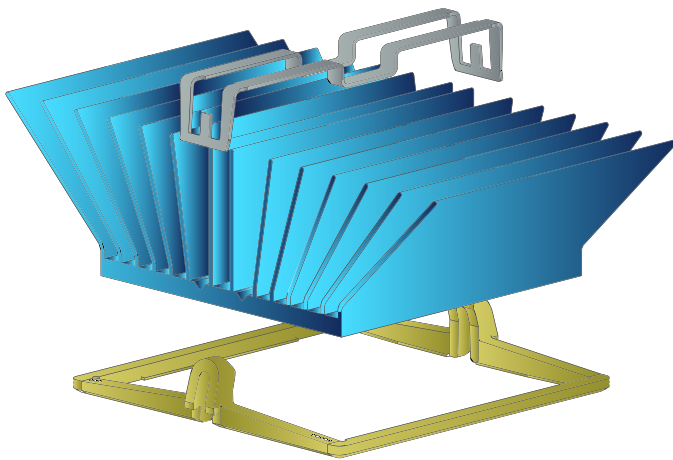

AVAILABLE COMPONENT SIZES (L X W)

15 mm x 15 mm
17 mm x 17 mm
19 mm x 19 mm
21 mm x 21 mm
23 mm x 23 mm
25 mm x 25 mm
27 mm x 27 mm
29 mm x 29 mm
30 mm x 30 mm
31 mm x 31 mm
32.5 mm x 32.5 mm
33 mm x 33 mm
35 mm x 35 mm
37.5 mm x 37.5 mm
40 mm x 40 mm
42.5 mm x 42.5 mm
45 mm x 45 mm

AVAILABLE HEAT SINK HEIGHTS

7.5 mm
12.5 mm
17.5 mm
(Custom sizes available)

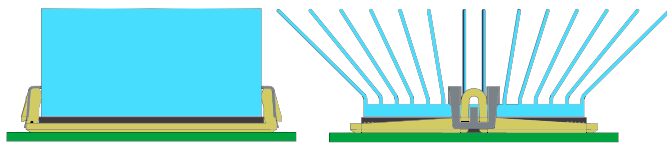

ATS' superGRIP™ patented frame and spring clips assembly

superGRIP™ FEATURES:

- Provides tight, secure heat sink attachment in shock and vibration environments
- superGRIP's strong, uniform attachment force helps achieve maximum performance from high performance phase-changing thermal interface materials
- Allows the heat sink to be detached and reattached without damaging the component or the PCB, an important feature in the event a PCB may need to be reworked
- Comes standard with clean break, reworkable, Chomerics T-766 phase change material

FRAME CLIP:

- Thin, yet strong plastic Frame Clip occupies minimal area around chip, allowing its use in densely populated PCBs
- No custom installation tooling required— mounts easily by hand.
- Interior frame profile locks securely around bottom edge and sides of component package
- Integral horseshoe tabs in clip lock in Spring Clip edges for tight, movement-free heat sink retention
- Frame Clip is easily and safely removed with a common hand tool

SPRING CLIP:

- Metal spring clip, placed through the heat sink's fin field, locks securely to both ends to the plastic frame and applies steady, even pressure to the component, improving thermal performance and long-term reliability
- Spring Clip design is quickly installed or released using a common hand tool, such as a flat blade screwdriver
- Flat, twin-channel clip provides stronger retention forces and minimizes spring clip movement